

PENNSYLVANIA GAME COMMISSION

SGL #138 ADMIN ROAD MAINTAINENCE

Southwest Region Forestry
Georges Township, Fayette County

Table of Contents

Bid Notice	(Provided Separately with Solicitation)
Terms and Conditions	(Provided Separately with Solicitation)
Project Specifications	4 Pages
PA Prevailing Wages	7 Pages (Determination No. 24-00661)
Reciprocal Limitations Act	4 Pages
Technical Specifications	29 Pages
Soil Erosion and Sedimentation Control Plan <i>(PA DEP Template for a Timber Harvesting Operation)</i>	21 Pages
Scope of Work – Sequence of Construction	4 Pages
Proposal Form Worksheet	2 Pages
Maps:	4 Pages
Location Map	
Aerial Image	
Topographic Map	
Soils Map	
Details:	11 Pages
Typical Road Section	
Turnout Detail	
Pipe Bedding Detail	
Stone Headwall Detail	
French Mattress	
Parking Area Detail	

PROJECT SPECIFICATIONS

The Contractor shall comply with the *Contract Terms and Conditions* provided with the Bid Documents including but not limited to the following:

INSURANCE REQUIREMENTS – In accordance with the *Contract Terms and Conditions*, the Contractor is required to have in place during the term of the Contract and any renewals or extensions thereof, the following types of insurance, issued by companies acceptable to the Commonwealth and authorized to conduct such business under the laws of the Commonwealth of Pennsylvania:

- A. **Worker's Compensation Insurance** for all of the Contractor's employees and those of any subcontractor, engaged in Work at the site of the project as required by law.

- B. **Public Liability and Property Damage Insurance** to protect the Commonwealth, the Contractor, and any and all subcontractors from claims for damages for personal injury (including bodily injury), sickness or disease, accidental death and damage to property including the loss of use resulting from any property damage, which may arise from the activities performed under the Contract or the failure to perform under the Contract, whether such performance or non-performance be by the Contractor, by any subcontractor, or by anyone directly or indirectly employed by either. **The minimum amounts of coverage shall be \$250,000 per person and \$1,000,000 per occurrence for bodily injury, including death, and \$250,000 per person and \$1,000,000 per occurrence for property damage.** Such policies shall be occurrence rather than claims-made policies and shall not contain any endorsements or any other form designated to limit and restrict any action by the Commonwealth, as an additional insured, against the insurance coverage in regard to Work performed for the Commonwealth.

Prior to commencement of the Work under the Contract and at each insurance renewal date during the term of the Contract, the Contractor shall provide the Commonwealth with current certificates of insurance. **These certificates or policies shall name the Commonwealth AND Pennsylvania Game Commission as additional insured and shall contain a provision that the coverage's afforded under the policies will not be cancelled or changed until at least thirty (30) days written notice has been given to the Commonwealth.**

COMPLIANCE WITH LAW – The Contractor shall comply with all applicable federal and state laws and regulations and local ordinances in the performance of the Contract.

WORKMANSHIP - All Work shall be performed in a Workmanlike manner and all materials and labor shall be in strict and entire conformity with the Drawings and Specifications.

INSPECTION AND CHANGES - All Work is subject to inspection and acceptance by the Pennsylvania Game Commission. Any Work rejected as defective or unsuitable shall be

removed and replaced with suitable Work and materials at the sole cost of the Contractor to the complete satisfaction of the Game Commission.

Changes shall be in accordance with the *Contract Terms and Conditions*.

TEMPORARY SERVICES AND JOB CONDITIONS - The Contractor shall be responsible for providing any and all temporary facilities necessary to execute and protect the Work. The Contractor shall accept all conditions as found upon examination of the site and shall coordinate, plan, and execute the Work accordingly. The Contractor shall cooperate in the arrangements of the Work as necessary to least affect the administration or operations of existing buildings, facilities, and infrastructure. The Contractor shall keep the Work site clean at all times.

PREVAILING WAGE – Prevailing minimum wages apply to this project. See *Contract Terms and Conditions* and attached Prevailing Wage Determination.

The Contractor and each Subcontractor shall file a statement each week and a final statement at the conclusion of the Work on the contract with the contracting agency, under oath, and in form satisfactory to the Secretary, certifying that workmen have been paid wages in strict conformity with the provisions of the contract as prescribed by this section or if wages remain unpaid to set forth the amount of wages due and owing to each workman respectively. The PA Labor and Industry “Weekly Payroll Certification for Public Works Projects” form shall be used. The initial and final Payroll Certifications shall be notarized.

PAYMENT TERMS - A schedule of values is provided with the bid. Payment will be made monthly upon satisfactory completion of items listed on the Schedule of Values and in accordance with the *Contract Terms and Conditions*.

All payments due to the Contractor shall be processed after all Work has been inspected and approved by an agent of the Pennsylvania Game Commission. Payment will not be made for Work that is not progressing satisfactorily or for unsuitable or defective Work.

Payments may be withheld for failure to provide required documentation for the project including but not limited to required submittals / shop drawings and weekly submission of Certified Payrolls.

INVOICING – All Project invoices shall be submitted directly to:

Commonwealth of PA – PO Invoices
P.O. Box 69180
Harrisburg, PA 17106

Or email a PDF invoice to 69180@pa.gov for payment.

Prior to sending invoice to PO address, a copy of invoice will be sent for review to:

Neil J. Itle, Southwest Regional Forester
Pennsylvania Game Commission
4820 Route 711
Bolivar PA 15923
Office: 1-833-HUNT – Ext 20218
Cell Phone 814-227-5019
Email: neitle@pa.gov

All invoices must be submitted in black and white with no color and shaded areas. Invoices must include the Purchase Order Number, Contractor's SAP Vendor Number, and the Contractor's name and address as listed on the Purchase Order. Payment items on invoices shall match the items on the Purchase Order. Failure to submit invoices that meet these requirements will result in a delay of payment.

Please Note: Vendors are reminded to NOT include employer identification numbers, Social Security Numbers, bank account information, or other personally identifiable information on their invoices. That information is uniquely tied to your SAP Vendor Number and, for security purposes, should not be explicitly stated on an invoice.

CONTRACT TERM - The Contract shall commence upon delivery of Purchase Order to Contractor and shall terminate on **June 30, 2024**. Contract time is of the essence of the Project. All Work must be completed and accepted by this date. Contract or Purchase Order extensions will only be approved if the contractor can demonstrate more time is required through no fault of their own.

EXCISE TAXES, PENNSYLVANIA SALES TAX - The Commonwealth is exempt from all Excise Taxes. See *Contract Terms and Conditions*.

OFFSET PROVISION - The Contractor agrees that the Commonwealth may set off the amount of any state liability or other debt of the Contractor or its subsidiaries that is owed to the Commonwealth and not being contested on appeal against any payments due the Contractor under this or any other contract with the Commonwealth.

PERFORMANCE SECURITY / CONTRACT BONDS – Within 10 days after award of the purchase order, the Bidder to whom the Contract is awarded, shall provide **Contract Performance Security** and a **Payment Bond** in a form acceptable to the Commonwealth for the amounts listed below and in accordance with the *Contract Terms and Conditions*.

A **Performance Bond** at one hundred percent (100%) of the contract amount, conditioned upon the faithful performance of the contract in accordance with the plans, specifications, and conditions of the contract.

A **Payment Bond** in an amount equal to one hundred percent (100%) of the contract amount.

Performance and Payment Bonds shall be executed by a surety company authorized to do business in the Commonwealth and listed on the current U.S. Dept. of Treasury, Bureau of Fiscal Service, Department Circular 570 (<https://fiscal.treasury.gov/surety-bonds/list-certified-companies.html>). Bonds shall include a current Power of Attorney dated the same as the date of the bond. Bonds shall be made payable to the Commonwealth.

GUARANTY / WARRANTY – See *Contract Terms and Conditions* – all items are warranted for a period of one year following delivery by the Contractor and acceptance by the Commonwealth.

HOLD HARMLESS PROVISION - See *Contract Terms and Conditions* - The Contractor shall hold the Commonwealth harmless from and indemnify the Commonwealth against any and all third party claims, demands and actions based upon or arising out of any activities performed by the Contractor and its employees and agents under this Contract, provided the Commonwealth gives Contractor prompt notice of any such claim of which it learns.

ADDITIONAL PROVISIONS -

Contractor shall comply with the conditions listed below in accordance with the *Contract Terms and Conditions*:

1. **Steel Products Procurement Act**
2. **Prohibition Against the Use of Certain Steel and Aluminum Products (Trade Practices Act)**
3. **Reciprocal Limitations Act** - The form GSPUR89 (*Reciprocal Limitations Act Requirements*) is attached. The Contractor shall complete the applicable portions of pages 3 and 4 of the form and submit the completed pages within two days after the bid opening.

**BUREAU OF LABOR LAW COMPLIANCE
PREVAILING WAGES PROJECT RATES**

Project Name:	SGL 138 Admin Road
Awarding Agency:	PA Game Commission
Contract Award Date:	2/29/2024
Serial Number:	24-00661
Project Classification:	Heavy/Highway
Determination Date:	1/23/2024
Assigned Field Office:	Pittsburgh
Field Office Phone Number:	(412)565-5300
Toll Free Phone Number:	(877)504-8354
Project County:	Fayette County

**BUREAU OF LABOR LAW COMPLIANCE
PREVAILING WAGES PROJECT RATES**

Project: 24-00661 - Building	Effective Date	Expiration Date	Hourly Rate	Fringe Benefits	Total
Asbestos & Insulation Workers	8/1/2022		\$41.40	\$28.51	\$69.91
Asbestos & Insulation Workers	8/1/2023		\$42.40	\$29.01	\$71.41
Boilermakers	6/1/2016		\$40.90	\$27.61	\$68.51
Bricklayer	12/1/2022		\$36.55	\$24.71	\$61.26
Carpenters - Piledriver/Welder	1/1/2023		\$40.63	\$21.22	\$61.85
Carpenters - Piledriver/Welder	1/1/2024		\$42.13	\$21.97	\$64.10
Carpenters - Piledriver/Welder	1/1/2025		\$43.38	\$22.72	\$66.10
Carpenters - Piledriver/Welder	1/1/2026		\$44.63	\$23.47	\$68.10
Carpenters, Drywall Hangers, Framers, Instrument Men, Lathers, Soft Floor Layers	6/1/2023		\$39.69	\$19.93	\$59.62
Carpenters, Drywall Hangers, Framers, Instrument Men, Lathers, Soft Floor Layers	6/1/2024		\$41.49	\$19.93	\$61.42
Carpenters, Drywall Hangers, Framers, Instrument Men, Lathers, Soft Floor Layers	6/1/2025		\$43.34	\$19.93	\$63.27
Cement Masons	6/1/2022		\$32.57	\$22.59	\$55.16
Cement Masons	6/1/2023		\$33.07	\$23.59	\$56.66
Drywall Finisher	6/1/2022		\$32.00	\$21.89	\$53.89
Drywall Finisher	6/1/2023		\$32.39	\$23.75	\$56.14
Drywall Finisher	6/1/2024		\$34.01	\$24.88	\$58.89
Electricians & Telecommunications Installation Technician	12/26/2022		\$48.31	\$29.29	\$77.60
Electricians & Telecommunications Installation Technician	12/22/2023		\$48.61	\$31.80	\$80.41
Electricians & Telecommunications Installation Technician	12/27/2024		\$51.76	\$31.80	\$83.56
Electricians & Telecommunications Installation Technician	12/26/2025		\$55.06	\$31.80	\$86.86
Elevator Constructor	1/1/2023		\$56.14	\$42.83	\$98.97
Elevator Constructor	1/1/2024		\$58.55	\$43.87	\$102.42
Glazier	9/1/2021		\$32.61	\$27.19	\$59.80
Glazier	9/1/2023		\$35.65	\$30.05	\$65.70
Iron Workers	6/1/2023		\$38.89	\$35.02	\$73.91
Laborers (Class 01 - See notes)	1/1/2023		\$25.82	\$19.46	\$45.28
Laborers (Class 01 - See notes)	1/1/2024		\$26.82	\$19.46	\$46.28
Laborers (Class 01 - See notes)	1/1/2025		\$27.32	\$19.96	\$47.28
Laborers (Class 01 - See notes)	1/1/2026		\$27.82	\$20.46	\$48.28
Laborers (Class 02 - See notes)	1/1/2023		\$25.97	\$19.46	\$45.43
Laborers (Class 02 - See notes)	1/1/2024		\$26.97	\$19.46	\$46.43
Laborers (Class 02 - See notes)	1/1/2025		\$27.47	\$19.96	\$47.43
Laborers (Class 02 - See notes)	1/1/2026		\$27.97	\$20.46	\$48.43
Laborers (Class 03 - See notes)	1/1/2023		\$28.97	\$19.46	\$48.43
Laborers (Class 03 - See notes)	1/1/2024		\$29.97	\$19.46	\$49.43
Laborers (Class 03 - See notes)	1/1/2025		\$30.47	\$19.96	\$50.43
Laborers (Class 03 - See notes)	1/1/2026		\$30.97	\$20.46	\$51.43
Laborers (Class 04 - See notes)	1/1/2021		\$23.57	\$19.32	\$42.89
Landscape Laborer (Skilled)	1/1/2020		\$21.64	\$16.98	\$38.62
Landscape Laborer (Skilled)	1/1/2023		\$23.79	\$18.28	\$42.07

**BUREAU OF LABOR LAW COMPLIANCE
PREVAILING WAGES PROJECT RATES**

Project: 24-00661 - Building	Effective Date	Expiration Date	Hourly Rate	Fringe Benefits	Total
Landscape Laborer (Skilled)	1/1/2024		\$24.79	\$18.53	\$43.32
Landscape Laborer (Skilled)	1/1/2025		\$25.79	\$18.78	\$44.57
Landscape Laborer (Skilled)	1/1/2026		\$26.79	\$19.03	\$45.82
Landscape Laborer (Tractor Operator)	1/1/2020		\$21.94	\$16.98	\$38.92
Landscape Laborer (Tractor Operator)	1/1/2023		\$24.09	\$18.28	\$42.37
Landscape Laborer (Tractor Operator)	1/1/2024		\$25.09	\$18.53	\$43.62
Landscape Laborer (Tractor Operator)	1/1/2025		\$26.09	\$18.78	\$44.87
Landscape Laborer (Tractor Operator)	1/1/2026		\$27.09	\$19.03	\$46.12
Landscape Laborer	1/1/2023		\$23.37	\$18.28	\$41.65
Landscape Laborer	1/1/2024		\$24.37	\$18.53	\$42.90
Landscape Laborer	1/1/2025		\$25.37	\$18.78	\$44.15
Landscape Laborer	1/1/2026		\$26.37	\$19.03	\$45.40
Millwright	6/1/2020		\$41.68	\$20.32	\$62.00
Operators (Class 01 - see notes)	6/1/2023		\$40.69	\$23.89	\$64.58
Operators (Class 01 - see notes)	6/1/2024		\$41.69	\$24.39	\$66.08
Operators (Class 02 -see notes)	6/1/2023		\$34.62	\$23.89	\$58.51
Operators (Class 02 -see notes)	6/1/2024		\$35.62	\$24.39	\$60.01
Operators (Class 03 - See notes)	6/1/2023		\$31.83	\$23.89	\$55.72
Operators (Class 03 - See notes)	6/1/2024		\$32.83	\$24.39	\$57.22
Painters Class 6 (see notes)	6/1/2022		\$29.50	\$22.82	\$52.32
Painters Class 6 (see notes)	6/1/2023		\$30.56	\$24.01	\$54.57
Painters Class 6 (see notes)	6/1/2024		\$32.14	\$24.93	\$57.07
Painters Class 6 (see notes)	6/1/2025		\$34.16	\$25.81	\$59.97
Pile Driver Divers (Building, Heavy, Highway)	1/1/2023		\$58.70	\$21.22	\$79.92
Pile Driver Divers (Building, Heavy, Highway)	1/1/2024		\$60.95	\$21.97	\$82.92
Pile Driver Divers (Building, Heavy, Highway)	1/1/2025		\$62.82	\$22.72	\$85.54
Pile Driver Divers (Building, Heavy, Highway)	1/1/2026		\$64.70	\$23.47	\$88.17
Piledrivers	1/1/2023		\$39.13	\$21.22	\$60.35
Piledrivers	1/1/2024		\$40.63	\$21.97	\$62.60
Piledrivers	1/1/2025		\$41.88	\$22.72	\$64.60
Piledrivers	1/1/2026		\$43.13	\$23.47	\$66.60
Plasterers	6/1/2022		\$31.44	\$19.74	\$51.18
Plasterers	6/1/2023		\$32.14	\$20.54	\$52.68
Plumbers and Steamfitters	6/1/2023		\$38.57	\$26.26	\$64.83
Pointers, Caulkers, Cleaners	12/1/2022		\$35.47	\$20.88	\$56.35
Roofers	6/1/2022		\$36.04	\$19.13	\$55.17
Roofers	6/1/2023		\$37.00	\$19.92	\$56.92
Sheet Metal Workers	7/1/2022		\$39.50	\$31.43	\$70.93
Sheet Metal Workers	8/1/2023		\$41.00	\$32.94	\$73.94
Sign Makers and Hangars	7/15/2022		\$30.54	\$24.35	\$54.89
Sign Makers and Hangars	7/15/2023		\$31.76	\$24.63	\$56.39
Sprinklerfitters	4/1/2023		\$44.33	\$28.04	\$72.37
Stone Masons	12/1/2022		\$38.56	\$23.61	\$62.17
Terrazzo Finisher	12/1/2022		\$36.13	\$18.03	\$54.16

**BUREAU OF LABOR LAW COMPLIANCE
PREVAILING WAGES PROJECT RATES**

Project: 24-00661 - Building	Effective Date	Expiration Date	Hourly Rate	Fringe Benefits	Total
Terrazzo Mechanics	12/1/2022		\$35.49	\$20.32	\$55.81
Tile Finisher	12/1/2022		\$28.76	\$17.34	\$46.10
Tile Setter	12/1/2022		\$35.64	\$21.81	\$57.45
Truckdriver class 1(see notes)	1/1/2023		\$33.18	\$22.21	\$55.39
Truckdriver class 1(see notes)	1/1/2024		\$34.93	\$22.71	\$57.64
Truckdriver class 1(see notes)	1/1/2025		\$36.43	\$23.21	\$59.64
Truckdriver class 1(see notes)	1/1/2026		\$37.93	\$23.71	\$61.64
Truckdriver class 2 (see notes)	1/1/2023		\$33.64	\$22.52	\$56.16
Truckdriver class 2 (see notes)	1/1/2024		\$35.39	\$23.02	\$58.41
Truckdriver class 2 (see notes)	1/1/2025		\$36.89	\$23.52	\$60.41
Truckdriver class 2 (see notes)	1/1/2026		\$38.39	\$24.02	\$62.41
Truckdriver class 3 (see notes)	1/1/2016		\$28.23	\$16.98	\$45.21
Window Film / Tint Installer	10/1/2019		\$25.00	\$2.63	\$27.63

**BUREAU OF LABOR LAW COMPLIANCE
PREVAILING WAGES PROJECT RATES**

Project: 24-00661 - Heavy/Highway	Effective Date	Expiration Date	Hourly Rate	Fringe Benefits	Total
Carpenter	1/1/2023		\$38.60	\$20.59	\$59.19
Carpenter	1/1/2024		\$40.10	\$21.34	\$61.44
Carpenter	1/1/2025		\$41.35	\$22.09	\$63.44
Carpenter	1/1/2026		\$42.60	\$22.84	\$65.44
Carpenter Welder	1/1/2023		\$40.10	\$20.59	\$60.69
Carpenter Welder	1/1/2024		\$41.60	\$21.34	\$62.94
Carpenter Welder	1/1/2025		\$42.85	\$22.09	\$64.94
Carpenter Welder	1/1/2026		\$44.10	\$22.84	\$66.94
Carpenters - Piledriver/Welder	1/1/2023		\$40.63	\$21.22	\$61.85
Carpenters - Piledriver/Welder	1/1/2024		\$42.13	\$21.97	\$64.10
Carpenters - Piledriver/Welder	1/1/2025		\$43.38	\$22.72	\$66.10
Carpenters - Piledriver/Welder	1/1/2026		\$44.63	\$23.47	\$68.10
Cement Finishers	1/1/2023		\$34.14	\$25.05	\$59.19
Cement Finishers	1/1/2024		\$35.14	\$26.30	\$61.44
Cement Finishers	1/1/2025		\$35.94	\$27.50	\$63.44
Cement Masons	1/1/2020		\$32.84	\$21.10	\$53.94
Electric Lineman	5/29/2023		\$52.56	\$29.99	\$82.55
Electric Lineman	6/3/2024		\$53.97	\$31.05	\$85.02
Iron Workers (Bridge, Structural Steel, Ornamental, Precast, Reinforcing)	6/1/2023		\$38.89	\$35.02	\$73.91
Laborers (Class 01 - See notes)	1/1/2023		\$29.95	\$25.50	\$55.45
Laborers (Class 01 - See notes)	1/1/2024		\$32.20	\$25.50	\$57.70
Laborers (Class 01 - See notes)	1/1/2025		\$33.70	\$26.00	\$59.70
Laborers (Class 01 - See notes)	1/1/2026		\$34.70	\$27.00	\$61.70
Laborers (Class 02 - See notes)	1/1/2023		\$30.11	\$25.50	\$55.61
Laborers (Class 02 - See notes)	1/1/2024		\$32.36	\$25.50	\$57.86
Laborers (Class 02 - See notes)	1/1/2025		\$33.86	\$26.00	\$59.86
Laborers (Class 02 - See notes)	1/1/2026		\$34.86	\$27.00	\$61.86
Laborers (Class 03 - See notes)	1/1/2023		\$30.50	\$25.50	\$56.00
Laborers (Class 03 - See notes)	1/1/2024		\$32.75	\$25.50	\$58.25
Laborers (Class 03 - See notes)	1/1/2025		\$34.25	\$26.00	\$60.25
Laborers (Class 03 - See notes)	1/1/2026		\$35.25	\$27.00	\$62.25
Laborers (Class 04 - See notes)	1/1/2023		\$30.95	\$25.50	\$56.45
Laborers (Class 04 - See notes)	1/1/2024		\$33.20	\$25.50	\$58.70
Laborers (Class 04 - See notes)	1/1/2025		\$34.70	\$26.00	\$60.70
Laborers (Class 04 - See notes)	1/1/2026		\$35.70	\$27.00	\$62.70
Laborers (Class 05 - See notes)	1/1/2023		\$31.36	\$25.50	\$56.86
Laborers (Class 05 - See notes)	1/1/2024		\$33.61	\$25.50	\$59.11
Laborers (Class 05 - See notes)	1/1/2025		\$35.11	\$26.00	\$61.11
Laborers (Class 05 - See notes)	1/1/2026		\$36.11	\$27.00	\$63.11
Laborers (Class 06 - See notes)	1/1/2023		\$28.20	\$25.50	\$53.70
Laborers (Class 06 - See notes)	1/1/2024		\$30.45	\$25.50	\$55.95
Laborers (Class 06 - See notes)	1/1/2025		\$31.95	\$26.00	\$57.95
Laborers (Class 06 - See notes)	1/1/2026		\$32.95	\$27.00	\$59.95
Laborers (Class 07 - See notes)	1/1/2023		\$30.95	\$25.50	\$56.45

**BUREAU OF LABOR LAW COMPLIANCE
PREVAILING WAGES PROJECT RATES**

Project: 24-00661 - Heavy/Highway	Effective Date	Expiration Date	Hourly Rate	Fringe Benefits	Total
Laborers (Class 07 - See notes)	1/1/2024		\$33.20	\$25.50	\$58.70
Laborers (Class 07 - See notes)	1/1/2025		\$34.70	\$26.00	\$60.70
Laborers (Class 07 - See notes)	1/1/2026		\$35.70	\$27.00	\$62.70
Laborers (Class 08 - See notes)	1/1/2023		\$32.45	\$25.50	\$57.95
Laborers (Class 08 - See notes)	1/1/2024		\$34.70	\$25.50	\$60.20
Laborers (Class 08 - See notes)	1/1/2025		\$36.20	\$26.00	\$62.20
Laborers (Class 08 - See notes)	1/1/2026		\$37.20	\$27.00	\$64.20
Millwright	6/1/2020		\$41.68	\$20.32	\$62.00
Millwright	6/1/2023		\$45.50	\$23.72	\$69.22
Millwright	6/1/2024		\$47.59	\$23.72	\$71.31
Millwright	6/1/2025		\$49.72	\$23.72	\$73.44
Operators (Class 01 - see notes)	1/1/2023		\$36.79	\$23.58	\$60.37
Operators (Class 01 - see notes)	1/1/2024		\$38.59	\$24.03	\$62.62
Operators (Class 01 - see notes)	1/1/2025		\$40.39	\$24.23	\$64.62
Operators (Class 02 -see notes)	1/1/2023		\$36.53	\$23.58	\$60.11
Operators (Class 02 -see notes)	1/1/2024		\$38.33	\$24.03	\$62.36
Operators (Class 02 -see notes)	1/1/2025		\$40.13	\$24.23	\$64.36
Operators (Class 03 - See notes)	1/1/2023		\$32.88	\$23.58	\$56.46
Operators (Class 03 - See notes)	1/1/2024		\$34.68	\$24.03	\$58.71
Operators (Class 03 - See notes)	1/1/2025		\$36.48	\$24.23	\$60.71
Operators (Class 04 - See notes)	1/1/2023		\$32.42	\$23.58	\$56.00
Operators (Class 04 - See notes)	1/1/2024		\$34.22	\$24.03	\$58.25
Operators (Class 04 - See notes)	1/1/2025		\$36.02	\$24.23	\$60.25
Operators (Class 05 - See notes)	1/1/2023		\$32.17	\$23.58	\$55.75
Operators (Class 05 - See notes)	1/1/2024		\$33.97	\$24.03	\$58.00
Operators (Class 05 - See notes)	1/1/2025		\$35.77	\$24.23	\$60.00
Operators Class 1-A	1/1/2023		\$39.79	\$23.58	\$63.37
Operators Class 1-A	1/1/2024		\$41.59	\$24.03	\$65.62
Operators Class 1-A	1/1/2025		\$43.39	\$24.23	\$67.62
Operators Class 1-B	1/1/2023		\$38.79	\$23.58	\$62.37
Operators Class 1-B	1/1/2024		\$40.59	\$24.03	\$64.62
Operators Class 1-B	1/1/2025		\$42.39	\$24.23	\$66.62
Painters Class 1 (see notes)	6/1/2022		\$34.45	\$22.82	\$57.27
Painters Class 2 (see notes)	6/1/2019		\$35.25	\$20.06	\$55.31
Painters Class 2 (see notes)	6/1/2023		\$36.01	\$24.01	\$60.02
Painters Class 2 (see notes)	6/1/2024		\$38.09	\$24.93	\$63.02
Painters Class 2 (see notes)	6/1/2025		\$40.36	\$25.81	\$66.17
Painters Class 3 (see notes)	6/1/2022		\$36.77	\$22.82	\$59.59
Painters Class 3 (see notes)	6/1/2023		\$38.33	\$24.01	\$62.34
Painters Class 3 (see notes)	6/1/2024		\$40.66	\$24.93	\$65.59
Painters Class 3 (see notes)	6/1/2025		\$43.69	\$25.81	\$69.50
Painters Class 4 (see notes)	6/1/2019		\$28.20	\$20.06	\$48.26
Painters Class 5 (see notes)	6/1/2019		\$22.91	\$20.06	\$42.97
Pile Driver Divers (Building, Heavy, Highway)	1/1/2023		\$58.70	\$21.22	\$79.92

**BUREAU OF LABOR LAW COMPLIANCE
PREVAILING WAGES PROJECT RATES**

Project: 24-00661 - Heavy/Highway	Effective Date	Expiration Date	Hourly Rate	Fringe Benefits	Total
Pile Driver Divers (Building, Heavy, Highway)	1/1/2024		\$60.95	\$21.97	\$82.92
Pile Driver Divers (Building, Heavy, Highway)	1/1/2025		\$62.82	\$22.72	\$85.54
Pile Driver Divers (Building, Heavy, Highway)	1/1/2026		\$64.70	\$23.47	\$88.17
Piledrivers	1/1/2023		\$39.13	\$21.22	\$60.35
Piledrivers	1/1/2024		\$40.63	\$21.97	\$62.60
Piledrivers	1/1/2025		\$41.88	\$22.72	\$64.60
Piledrivers	1/1/2026		\$43.13	\$23.47	\$66.60
Steamfitters (Heavy and Highway - Gas Distribution)	5/1/2022		\$48.43	\$40.28	\$88.71
Truckdriver class 1(see notes)	1/1/2023		\$33.18	\$22.21	\$55.39
Truckdriver class 1(see notes)	1/1/2024		\$34.93	\$22.71	\$57.64
Truckdriver class 1(see notes)	1/1/2025		\$36.43	\$23.21	\$59.64
Truckdriver class 1(see notes)	1/1/2026		\$37.93	\$23.71	\$61.64
Truckdriver class 2 (see notes)	1/1/2023		\$33.64	\$22.52	\$56.16
Truckdriver class 2 (see notes)	1/1/2024		\$35.39	\$23.02	\$58.41
Truckdriver class 2 (see notes)	1/1/2025		\$36.89	\$23.52	\$60.41
Truckdriver class 2 (see notes)	1/1/2026		\$38.39	\$24.02	\$62.41
Truckdriver class 3 (see notes)	1/1/2019		\$29.59	\$19.82	\$49.41

RECIPROCAL LIMITATIONS ACT REQUIREMENTS

Please Complete Applicable Portion of Pages 3 & 4 and Return with Bid.

NOTE: These Requirements Do Not Apply To Bids Under \$10,000.00

I. REQUIREMENTS

- A.** The Reciprocal Limitations Act requires the Commonwealth to give preference to those bidders offering supplies produced, manufactured, mined or grown in Pennsylvania as against those bidders offering supplies produced, manufactured, mined or grown in any state that gives or requires a preference to supplies produced, manufactured, mined or grown in that state. The amount of the preference shall be equal to the amount of the preference applied by the other state for that particular supply.

The following is a list of states which have been found by the Department of General Services to have applied a preference for in-state supplies and the amount of the preference:

	STATE	PREFERENCE
1.	Alaska	7% (applies only to timber, lumber, and manufactured lumber products originating in the state)
2.	Arizona	5% (construction materials produced or manufactured in the state only)
3.	Hawaii	10%
4.	Illinois	10% for coal only
5.	Iowa	5% for coal only
6.	Louisiana	4% meat and meat products 4% catfish 10% milk & dairy products 10% steel rolled in Louisiana 7% all other products
7.	Montana	5% for residents * 3% for non-residents* *offering in-state goods, supplies, equipment and materials
8.	New Mexico	5%
9.	New York	3% for purchase of food only
10.	Oklahoma	5%
11.	Virginia	4% for coal only
12.	Washington	5% (fuels mined or produced in the state only)
13.	Wyoming	5%

- B.** The Reciprocal Limitations Act requires the Commonwealth to give preference to those bidders offering printing performed in Pennsylvania as against those bidders offering printing performed in any state that gives or requires a preference to printing performed in that state. The amount of the preference shall be equal to the amount of the preference applied by the other state for that particular category of printing.

The following is a list of states which have been found by the Department of General Services to have applied a preference for in-state printing and the amount of the preference:

	STATE	PREFERENCE
1.	Hawaii	15%
2.	Idaho	10%
3.	Louisiana	3%
4.	Montana	8%
5.	New Mexico	5%
6.	Wyoming	10%

- C.** The Reciprocal Limitations Act, also requires the Commonwealth to give resident bidders a preference against a nonresident bidder from any state that gives or requires a preference to bidders from that state or exclude bidders from states that exclude nonresident bidders. The amount of the preference shall be equal to the amount of the preference applied by the state of the nonresident bidder. The following is a list of the states which have been found by the Department of General Services to have applied a preference for in-state bidders and the amount of the preference:

STATE	PREFERENCE
1. Alaska	5% (supplies only)
2. Arizona	5% (construction materials from Arizona resident dealers only)
3. California	5% (for supply contracts only in excess of \$100,000.00)
4. Connecticut	10% (for supplies only)
5. Montana	3%
6. New Mexico	5% (for supplies only)
7. South Carolina	2% (under \$2,500,000.00) 1% (over \$2,500,000.00)
	This preference does not apply to construction contracts nor where the price of a single unit exceeds \$10,000.
8. West Virginia	2.5% (for the construction, repair or improvement of any buildings)
9. Wyoming	5%

STATE	PROHIBITION
1. New Jersey	For supply procurements or construction projects restricted to Department of General Services Certified Small Businesses, New Jersey bidders shall be excluded from award even if they themselves are Department of General Services Certified Small Businesses.

D. The Reciprocal Limitations Act also requires the Commonwealth not to specify, use or purchase supplies which are produced, manufactured, mined or grown in any state that prohibits the specification for, use, or purchase of such items in or on its public buildings or other works, when such items are not produced, manufactured, mined or grown in such state. The following is a list of the states which have been found by the Department of General Services to have prohibited the use of out-of-state supplies:

STATE	PROHIBITION
1. Alabama	Only for printing and binding involving "messages of the Governor to the Legislature", all bills, documents and reports ordered by and for the use of the Legislature or either house thereof while in session; all blanks, circulars, notices and forms used in the office of or ordered by the Governor, or by any state official, board, commission, bureau or department, or by the clerks of the supreme court . . ./and other appellate courts/; and all blanks and forms ordered by and for the use of the Senate and Clerk or the House of Representatives, and binding the original records and opinions of the Supreme Court . . . /and other appellate courts/
2. Georgia	Forest products only
3. Indiana	Coal
4. Michigan	Printing
5. New Mexico	Construction
6. Ohio	Only for House and Senate bills, general and local laws, and joint resolutions; the journals and bulletins of the Senate and house of Representatives and reports, communications, and other documents which form part of the journals; reports, communications, and other documents ordered by the General Assembly, or either House, or by the executive department or elective state officers; blanks, circulars, and other work for the use of the executive departments, and elective state officers; and opinions of the Attorney General.
7. Rhode Island	Only for food for state institutions.

*If the bid discloses that the bidder is offering to supply one of the above-listed products that is manufactured, mined, or grown in the listed state, it shall be rejected. Contractors are prohibited from supplying these items from these states.

II. CALCULATION OF PREFERENCE

In calculating the preference, the amount of a bid submitted by a Pennsylvania bidder shall be reduced by the percentage preference which would be given to a nonresident bidder by its state of residency (as found by the Department of General Services in Paragraph C_above). Similarly, the amount of a bid offering Pennsylvania goods, supplies, equipment or materials shall be reduced by the percentage preference which would be given to another bidder by the state where the goods, supplies, equipment or materials are produced, manufactured, mined or grown (as found by the Department of General Services in Paragraphs A and B above).

THIS FORM MUST BE COMPLETED AND RETURNED WITH THE BID

III. STATE OF MANUFACTURE

All bidders must complete the following chart by listing the name of the manufacturer and the state (or foreign country) of manufacture for each item. If the item is domestically produced, the bidder must indicate the state in the United States where the item will be manufactured. **This chart must be completed and submitted with the bid or no later than two (2) business days after notification from the Issuing Office to furnish the information. Failure to complete this chart and provide the required information prior to the expiration of the second business day after notification shall result in the rejection of the bid.**

ITEM NUMBER	NAME OF MANUFACTURER	STATE (OR FOREIGN COUNTRY) OF MANUFACTURE

IV. BIDDER'S RESIDENCY

A. In determining whether the bidder is a nonresident bidder from a state that gives or requires a preference to bidders from that state, the address given on the first page of this invitation to bid shall be used by the Commonwealth. If that address is incorrect, or if no address is given, the correct address should be provided in the space below:

Correct Address: _____

- B.** In order to claim the preference provided under Section I.B., Pennsylvania resident bidders must complete the following or have such information on file with the Issuing Office:
- 1.** Address of bidder's bona fide establishment in Pennsylvania at which it was transacting business on the date when bids for this contract/requisition were first solicited: _____
 - 2. a.** If the bidder is a corporation:
 - (1)** The corporation is or is not incorporated under the laws of the Commonwealth of Pennsylvania.
 - (a)** If the bidder is incorporated under the laws of the Commonwealth of Pennsylvania, provide date of incorporation: _____
 - (b)** If the bidder is not incorporated under the laws of the Commonwealth of Pennsylvania, it must have a certificate of authority to do business in the Commonwealth of Pennsylvania from the Pennsylvania Department of State as required by the Pennsylvania Business Corporation Law (15 P.S. §2001). Provide date of issuance of certificate of authority: _____
 - (2)** The corporation is or is not conducting business in Pennsylvania under an assumed or fictitious name. If the bidder is conducting business under an assumed or fictitious name, it must register the fictitious name with the Secretary of the Commonwealth and the office of the prothonotary of the county wherein the registered office of such corporation is located as required by the Fictitious Corporate Name Act, as amended 15 P.S. §51 et seq. Corporate bidders conducting business under an assumed or fictitious name must provide date of registry of the assumed or fictitious name: _____
 - b.** If the bidder is a partnership:
 - (1)** The partnership is or is not conducting business in Pennsylvania under an assumed or fictitious name. If the bidder is conducting business under an assumed or fictitious name, it must file with the Secretary of the Commonwealth and the office of the prothonotary the county wherein the principal place of business is located as required by the Fictitious Name Act of May 24, 1945, P.L. 967, as amended 54 P.S. §28.1. Partnerships conducting business under an assumed or fictitious name must provide the date of filing of the assumed or fictitious name with the Secretary of the Commonwealth: _____
 - (2)** The partnership is or is not a limited partnership formed under the laws of any jurisdiction other than the Commonwealth of Pennsylvania. If the bidder is an Out-of-state limited partnership, it must register with the Pennsylvania Department of State as required by the Act of July 10, 1981, P.L. 237, as amended, 59 Pa. C.S.A. §503. Out-of-state limited partnerships must provide the date of registry with the Pennsylvania Department of State: _____
 - c.** If the bidder is an individual:

He or she is or is not conducting business under an assumed or fictitious name. If the bidder is conducting business under an assumed or fictitious name, he or she must file with the Secretary of the Commonwealth and the office of the prothonotary in the county wherein the principal place of business is located as required by the Fictitious Name Act of May 24, 1945, P.L. 967, as amended, 54 P.S. §28.1. Individuals conducting business under an assumed or fictitious name must provide the date of filing of the assumed or fictitious name with the Secretary of the Commonwealth: _____

TECHNICAL SPECIFICATIONS

The following stipulations, specifications and description of Work are defined and described as Technical Specifications and it is understood and agreed that everything herein contained is hereby made part of the Contract. Wherever any feature of the Work is not fully set forth in these Technical Specifications and is necessary for the completion of Work, it shall be understood that the same is governed by the rules of the best prevailing practice for that class of Work, as determined by the Pennsylvania Game Commission and its representatives.

These Technical Specifications and any drawings, details, maps and/or plans forming a part thereof, will cover the furnishing of all labor, equipment, tools, materials, and related items necessary to perform the Work, as required under this Contract.

- Section 1 – Summary of Work
- Section 2 – Measurement and Payment
- Section 3 – Clearing and Grubbing
- Section 4 – Excavation
- Section 5 – Road Surface Preparation and Construction
- Section 6 – Drain Pipe
- Section 7 – Head Wall Construction
- Section 8 – French Mattress
- Section 9 – Erosion and Sedimentation Control
- Section 10 – Restoration

TECHNICAL SPECIFICATION SECTION 1 - SUMMARY OF WORK

1.1 – SCOPE OF PROJECT

The project generally involves grubbing, grading, drainage, road subbase maintenance, road resurfacing and related work on approximately 6,145 linear feet of existing roadway in Georges Township, Fayette County.

1.2 – WORK AREA

SGL #138 Fayette County - see Location Map included with the Bid Documents. The site is owned by the Pennsylvania Game Commission (PGC).

1.3 – WORK HOURS

The work hours at the project site are during regular PGC business hours which are Monday through Friday, 7:30AM to 4:00PM. Work during different hours must have prior written approval by the PGC Regional Forester. Requests for different working hours must be submitted in writing three days in advance. No work will be permitted on Saturdays or Sundays except as expressly authorized by the PGC Regional Forester.

Work will be restricted during hunting seasons. Work during November through March will be weather and site conditions dependent. No Work or construction operations will be permitted during the following days and periods:

- **All Saturdays in the months of October, November, December, and January and any Sundays open to hunting.**
- **The opening day and all Saturdays during spring turkey season, including the youth spring gobbler hunt.**
- **All the days of the general statewide bear season.**
- **The entire 2 weeks of the general firearms deer season.**
- **The opening day of the flintlock muzzleloader season.**
- **Construction operations may be suspended during Spring break up (March 1 through April 15). No operations will be permitted without the permission of the PGC Regional Forester.**

*Any variance from the Non-Work Days must have advanced approval from the Regional Forester.

The Contractor shall provide notice to the Regional Forester at least 96 hours (4 days) prior to start of the work.

1.4 – ACCESS TO WORK AREA

Access to the project sites and staging of equipment and materials shall be coordinated with the PGC. The Contractor shall keep access roads leading to the project sites open for use by the PGC. The Contractor is required to repair any ruts or other damage to the access roads and parking areas caused by construction equipment.

All equipment shall be cleaned of soil and debris before being moved onto site to prevent spread of invasive species.

1.5 – CONTROL OF WORK AREA

Coordinate with PGC staff for access and control of work areas. Provide barricades, signs and other devices as needed to prevent unauthorized access to work areas until construction activities are completed and parking areas are opened for public use.

All PGC gates on State Game Land roads used to access the project site shall be closed and locked at the end of each workday unless other arrangements are coordinated with PGC staff.

Do not block public roads at any time during construction. If necessary, provide temporary Maintenance and Control of Traffic in accordance with PennDOT Pub. 213 Temporary Traffic Control Guidelines and related PennDOT references.

Provide and maintain construction warning signs, truck crossing signs, etc. during active work and construction operations.

Damage to trails, roads, parking areas, gates, culverts, streams, rights-of-way, infrastructure, and property caused by the Contractor's equipment shall be repaired or restored to original condition at no additional cost.

All trash and construction debris / waste shall be removed from the project site and properly disposed of. Burning is not permitted on State Game Lands.

The Contractor is responsible for the control and collection of fluids leaking from any equipment used on the site. The Contractor shall provide spill containment and cleanup kits appropriate for the equipment being used. At a minimum, the kits shall contain; plugs and clamps to control hydraulic line breaks, a container to collect leaking fluids, fluid absorbent pads, heavy duty trash bags, and a shovel. The Contractor shall collect and control fluids leaking from any equipment and dispose of properly. The Contractor shall contain and cleanup all fluid spills and properly dispose of contaminated fluids, materials, and soils at an approved waste disposal / recycling site or facility. Operating equipment noticeably leaking fluids on State Game Lands is prohibited.

The Contractor, employees, and sub-contractors may not hunt to, from, or at the job site when the work location is beyond a gated road that is closed to public traffic. The

Contractor may travel to and from the work location on non-workdays to check on the condition of equipment.

1.6 – PERMITS, LAWS AND REGULATIONS

The Contractor shall procure and pay for all permits, licenses, inspections, conveniences, or other approvals necessary for the execution of the contract. The PGC is not aware of any permits required for this project.

The Contractor shall comply with all laws, ordinances, rules, orders, and regulations relating to the performance of the work, the protection of adjacent property, the maintaining of surface passageways, guard fences, and/or other protective facilities.

All applicable Federal and State laws and regulations, municipal ordinances and rules and regulations of all authorities, having jurisdiction over construction of the project shall apply to the contract throughout, and they shall be deemed to be included in the contract as a part, thereof, the same as though herein written out in full.

All regulations of the Occupational Safety and Health Act are in effect on this contract. It will be the Contractor's responsibility to make himself aware of all appropriate County, State and Federal regulations that apply to this contract.

Any violations incurred from improper execution of the above provisions shall be paid for by the Contractor. Loss of time on the project from such violations will not be tolerated.

It is unlawful to be present on State Game Lands from November 15 through December 15 inclusive when not engaged in lawful hunting or trapping and fail to wear a minimum of 250 square inches of daylight fluorescent-orange material on the head, chest, and back combined, or in lieu thereof, a hat of the same colored material. The material shall be worn so it is visible in a 360-degree arc.

1.7 – PROTECTION OF UTILITIES - PA ONE CALL (ACT 287 of 1974 as amended)

The Contractor shall comply with Act 287 (as amended) and the "*Underground Utility Line Protection Law*" when Work involves excavation and earthmoving activities as defined by the Act. The Contractor shall contact the Pennsylvania One Call System, Inc. by phone at 1-800-242-1776 or their website (www.palcall.org) to notify affected utilities and to coordinate utility locations prior to earthwork and excavation operations at the site.

1.8 – ROAD PERMITS AND BONDING

The Contractor shall coordinate, acquire, pay for, and maintain for the duration of the project any and all permits or bonds required by local municipalities and/or PennDOT to utilize public roads and infrastructure for heavy hauling and related construction activities. Responsibilities shall include any pre or post construction inspections and related reports if required. All costs

related to permitting and bonding public roadways and infrastructure shall be included with and incidental to the Bid submitted by the Contractor and will not be paid for separately.

1.8.1 US / STATE ROADS

Operator may contact Tom Rebovich, Penn DOT District 12-0, Fayette County at 724-439-7349 for permitting and/or bonding information for any State Roads to be used. For additional information go to <http://www.papostedroads.pa.gov/>

FAYETTE COUNTY

Skyline Road (SR2001)

1.8.2 LOCAL ROADS

The use of any township road is to be coordinated with Township Supervisors.

1.9 – EQUIPMENT

The PGC reserves the right to inspect/evaluate Contractor provided equipment used to complete the project. If in the opinion of the PGC staff the equipment is not adequate to meet the requirements of the contract, the Contractor shall provide other equipment acceptable to the PGC staff for the project. If the Contractor does not provide adequate equipment to complete the project the contract will be terminated. The decision of the PGC staff Officer in Charge as it relates to proper equipment and its ability to complete the work will be final.

Adequate equipment required to complete the project shall remain on site for the duration of the project. If equipment is removed from the site and is later needed to finish the required work and restoration or to perform repairs / corrections, the Contractor shall remobilize and provide necessary equipment to complete the work to the satisfaction of the PGC staff. No separate or additional payment will be made to remobilize equipment to the project site.

1.10 – FINAL INSPECTION

Final inspection of the project will be conducted by PGC staff. The Contractor may be present at the final inspection. Upon successful completion of the required work, restoration of disturbed or damaged areas and/or infrastructure, submission of all required project documentation, certified payrolls, aggregate load slips, etc., final payment will be released to the Contractor.

1.11 – MEASUREMENT AND PAYMENT

See Technical Specification Section 2 for description of pay items.

TECHNICAL SPECIFICATION SECTION 2 – MEASUREMENT AND PAYMENT

2.1 – GENERAL

- A. The items on the Bid Form for this Contract will be measured and the payment made in accordance with this Section.
- B. All payments will be made at the unit prices for each item listed in the Bid Form.
- C. Any items not specifically listed on the Bid Form but are specified and/or are necessary to complete the Work will be considered incidental to the related items listed on the Bid Form.

2.2 – PAY ITEMS AND MEASUREMENT METHODS

Pay items are listed in the order they appear on the Bid Form and unless stated otherwise, the numbers correspond to the Pay Item Numbers on the Bid Form and the Purchase Order.

- 1. ADMINISTRATION, MOBILIZATION, TERMS AND CONDITIONS, CONTRACT BONDS
 - a. This price and payment shall constitute full compensation for providing Performance and Payment Bonds, insurance coverage and certificates, compliance with the Terms and Conditions, and general project requirements except where specifically described and scheduled elsewhere, mobilization, demobilization, temporary facilities, municipal and state (PennDOT) roadway bonding requirements / fees and costs / inspections, and compliance with requirements of permits and approvals (not measured and paid for elsewhere) required for the project by the Contract Documents.
 - b. Unit of Measurement: Lump Sum.
- 2. SOIL EROSION AND SEDIMENTATION CONTROL
 - a. This price and payment shall constitute full compensation for providing Soil Erosion and Sedimentation Controls and constructing a long tail ditch as specified and shown and directed by PGC staff including but not limited to all labor, materials, equipment, supervision, and related work and incidental items required to prevent accelerated soil erosion and surface water contamination and to address and correct erosion problems that occur during construction.
 - b. Unit of Measurement: Lump Sum
- 3. CLEARING AND GRUBBING –ALONG ROADWAY
 - a. This price and payment shall constitute full compensation for providing Clearing and Grubbing operations at the road entrance, along the roadway corridor and expanded parking areas as needed as specified and as directed by PGC staff including but not

limited to all labor, materials, equipment, supervision, protection of trees to remain, tree cutting, tree removal, stump removal, brush and vegetation clearing, disposal of waste materials, and other related work required to clear and prepare the corridor for the roadway work.

- b. Unit of Measurement: Lump Sum

4. GRADE AND SHAPE ROADWAY

- a. This price and payment shall constitute full compensation to grade and shape the existing roadway and roadway entrance as specified and shown on the drawings / details and directed by PGC staff including but not limited to all labor, materials, equipment, supervision, excavation and earthwork operations, cut / fill excavation and earthwork operations, excavation and removal of existing earth berms, borrow site excavation and fill operations (if required), compaction of subgrade; excavations / grading required to create ditches, turnouts, tail ditches, grade breaks, and broad based dips; disposal of excess / waste materials, and related work required to provide the roadway subgrade. Contractor shall provide adequate construction excavation and earthmoving equipment suitable for the required work including but not limited to a dozer with a 6-way blade, grader, and excavator.
- b. Unit of Measurement: Linear Foot measured horizontally along the roadway based on the Typical Road Section detail.

5. 15" DRAIN PIPE

- a. This price and payment shall constitute full compensation to provide drain pipe of the size and type specified and shown and as directed by PGC staff including but not limited to all labor, materials, equipment, supervision, excavation and earthwork operations, miscellaneous pipe fittings / accessories, disposal of waste excavated materials, riprap lined pipe discharge apron (if required), and related work required to provide the drain pipe.
- b. Unit of Measurement: Linear Foot measured horizontally along the pipe.

6. DRAIN PIPE BEDDING AND BACKFILL – PENNDOT 2A COARSE AGGREGATE

- a. This price and payment shall constitute full compensation to provide coarse aggregate bedding and backfill for drain pipes as specified and shown and as directed by PGC staff including but not limited to all labor, materials, equipment, supervision, excavation and earthwork operations, compaction, and related work required to provide the bedding and backfill.

- b. Unit of Measurement: Tons – Loose as shipped and dumped at the site. Quantity in Bid is estimated based on anticipated volume required. Actual quantity measured and paid shall be based on load slips provided by the aggregate supplier / quarry where the material is obtained and weighed. **The Contractor shall provide copies of ALL aggregate load slips including a project summary sheet provided by the aggregate supplier for verification of quantities and quality control. Load slips shall include the following minimum information: 1) supplier, 2) contractor, 3) project name, 4) aggregate type, 5) quantity delivered (tons), 6) delivery date, and 7) specific delivery location. In addition to individual load / weigh slips, a summary spreadsheet in Microsoft Excel format of all aggregate material shipments shall be provided.**

7. STONE HEADWALLS

- a. This price and payment shall constitute full compensation to provide drainage pipe headwalls of the size and type specified and shown and as directed by PGC staff including but not limited to all labor, materials, equipment, supervision, excavation and earthwork operations, miscellaneous/ accessories, and related work required to provide and install the headwalls.
- b. Unit of Measurement: Each – Per headwall on individual drainage pipes.

8. R-4 LIMESTONE RIP RAP DISCHARGE APRONS

- a. This price and payment shall constitute full compensation to provide R-4 Limestone Rip Rap as specified and shown and directed by PGC staff including but not limited to all labor, materials, equipment, supervision, aggregate spreading and grading, compaction, and related work required to provide the drain pipe discharge aprons and tail ditch.
- b. Unit of Measurement: Tons – Loose as shipped and dumped at the site. Quantity in Bid is estimated based on anticipated volume required. Actual quantity measured and paid shall be based on load slips provided by the aggregate supplier / quarry where the material is obtained and weighed. **The Contractor shall provide copies of ALL aggregate load slips including a project summary sheet provided by the aggregate supplier for verification of quantities and quality control. Load slips shall include the following minimum information: 1) supplier, 2) contractor, 3) project name, 4) aggregate type, 5) quantity delivered (tons), 6) delivery date, and 7) specific delivery location. In addition to individual load / weigh slips, a summary spreadsheet in Microsoft Excel format of all aggregate material shipments shall be provided.**

9. FRENCH MATTRESS

- a. This price and payment shall constitute full compensation to provide a French Mattress of the size and type specified and shown and as directed by PGC staff including but not limited to all labor, stone, materials, equipment, supervision, excavation and earthwork

operations, miscellaneous/ accessories, and related work required to provide and install the mattress.

- b. Unit of Measurement: Lump Sum

10. NON-WOVEN GEOTEXTILE FABRIC

- a. This price and payment shall constitute full compensation to provide and install Non-woven geotextile fabric of the size and type specified and as directed by PGC staff including but not limited to all labor, materials, equipment, supervision, excavation and earthwork operations, miscellaneous/ accessories, and related work required to provide and install the fabric.
- b. Unit of Measurement: Linear Feet

11. AASHTO #1 COARSE AGGREGATE SUBBASE AS NEEDED – ROADWAY & PARKING AREAS

- a. This price and payment shall constitute full compensation to provide 3A Modified Coarse Aggregate Limestone roadway base, as needed, as specified and shown and directed by PGC staff including but not limited to all labor, materials, equipment, supervision, aggregate spreading and grading, compaction, and related work required to provide the coarse aggregate surface.
- c. Unit of Measurement: Tons – Loose as shipped and dumped at the site. Quantity in Bid is estimated based on anticipated volume required. Actual quantity measured and paid shall be based on load slips provided by the aggregate supplier / quarry where the material is obtained and weighed. **The Contractor shall provide copies of ALL aggregate load slips including a project summary sheet provided by the aggregate supplier for verification of quantities and quality control. Load slips shall include the following minimum information: 1) supplier, 2) contractor, 3) project name, 4) aggregate type, 5) quantity delivered (tons), 6) delivery date, and 7) specific delivery location. In addition to individual load / weigh slips, a summary spreadsheet in Microsoft Excel format of all aggregate material shipments shall be provided.**

12. 3A MODIFIED COARSE AGGREGATE LIMESTONE BASE- ROADWAY

- a. This price and payment shall constitute full compensation to provide 3A Modified Coarse Aggregate Limestone roadway base as specified and shown and directed by PGC staff including but not limited to all labor, materials, equipment, supervision, aggregate spreading and grading, compaction, and related work required to provide the coarse aggregate surface.
- b. Unit of Measurement: Tons – Loose as shipped and dumped at the site. Quantity in Bid is estimated based on anticipated volume required. Actual quantity measured and paid shall be based on load slips provided by the aggregate supplier / quarry where the material is

obtained and weighed. **The Contractor shall provide copies of ALL aggregate load slips including a project summary sheet provided by the aggregate supplier for verification of quantities and quality control. Load slips shall include the following minimum information: 1) supplier, 2) contractor, 3) project name, 4) aggregate type, 5) quantity delivered (tons), 6) delivery date, and 7) specific delivery location. In addition to individual load / weigh slips, a summary spreadsheet in Microsoft Excel format of all aggregate material shipments shall be provided.**

13. PENNDOT 2A COARSE AGGREGATE LIMESTONE SURFACE - ROADWAY

- a. This price and payment shall constitute full compensation to provide PennDOT 2A Coarse Aggregate Limestone roadway surface as specified and shown and directed by PGC staff including but not limited to all labor, materials, equipment, supervision, aggregate spreading and grading, compaction, and related work required to provide the coarse aggregate surface.
- b. Unit of Measurement: Tons – Loose as shipped and dumped at the site. Quantity in Bid is estimated based on anticipated volume required. Actual quantity measured and paid shall be based on load slips provided by the aggregate supplier / quarry where the material is obtained and weighed. **The Contractor shall provide copies of ALL aggregate load slips including a project summary sheet provided by the aggregate supplier for verification of quantities and quality control. Load slips shall include the following minimum information: 1) supplier, 2) contractor, 3) project name, 4) aggregate type, 5) quantity delivered (tons), 6) delivery date, and 7) specific delivery location. In addition to individual load / weigh slips, a summary spreadsheet in Microsoft Excel format of all aggregate material shipments shall be provided.**

14. EXCAVATE, GRADE AND SHAPE PARKING AREAS - SECTION "B"

- a. This price and payment shall constitute full compensation for providing excavation, and grading operations for parking area improvements as specified and as directed by PGC staff including but not limited to all labor, materials, equipment, supervision, protection of trees to remain, tree cutting, tree removal, stump removal, brush and vegetation clearing, disposal of waste materials, and other related work required to clear and prepare the work area.
- b. Unit of Measurement: Lump Sum

15. 3A MODIFIED COARSE AGGREGATE LIMESTONE PARKING AREA BASE – SECTION "B"

- a. This price and payment shall constitute full compensation to provide 3A Modified Coarse Aggregate Limestone parking area base as specified and shown and directed by PGC staff including but not limited to all labor, materials, equipment, supervision, aggregate spreading and grading, compaction, and related work required to provide the coarse aggregate base.

- b. Unit of Measurement: Tons – Loose as shipped and dumped at the site. Quantity in Bid is estimated based on anticipated volume required. Actual quantity measured and paid shall be based on load slips provided by the aggregate supplier / quarry where the material is obtained and weighed. **The Contractor shall provide copies of ALL aggregate load slips including a project summary sheet provided by the aggregate supplier for verification of quantities and quality control. Load slips shall include the following minimum information: 1) supplier, 2) contractor, 3) project name, 4) aggregate type, 5) quantity delivered (tons), 6) delivery date, and 7) specific delivery location. In addition to individual load / weigh slips, a summary spreadsheet in Microsoft Excel format of all aggregate material shipments shall be provided.**

16. PENNDOT 2A COARSE AGGREGATE - LIMESTONE PARKING AREA SURFACE – SECTION “B”

- a. This price and payment shall constitute full compensation to provide PennDOT 2A Coarse Aggregate Limestone parking area surface as specified and shown and directed by PGC staff including but not limited to all labor, materials, equipment, supervision, aggregate spreading and grading, compaction, and related work required to provide the coarse aggregate surface.
- b. Unit of Measurement: Tons – Loose as shipped and dumped at the site. Quantity in Bid is estimated based on anticipated volume required. Actual quantity measured and paid shall be based on load slips provided by the aggregate supplier / quarry where the material is obtained and weighed. **The Contractor shall provide copies of ALL aggregate load slips including a project summary sheet provided by the aggregate supplier for verification of quantities and quality control. Load slips shall include the following minimum information: 1) supplier, 2) contractor, 3) project name, 4) aggregate type, 5) quantity delivered (tons), 6) delivery date, and 7) specific delivery location. In addition to individual load / weigh slips, a summary spreadsheet in Microsoft Excel format of all aggregate material shipments shall be provided.**

17. RESTORATION – SECTION “C”

- a. This price and payment shall constitute full compensation to grade, stabilize and restore all disturbed areas along the roadway corridor and the borrow pit as specified and shown and directed by PGC staff including but not limited to all labor, materials, equipment, supervision, seed mixtures, mulches, soil amendments, and related work.
- b. Unit of Measurement: Lump Sum

TECHNICAL SPECIFICATION SECTION 3 – CLEARING AND GRUBBING

3.1 -SCOPE

This work includes incidental removal and disposal of trees, stumps, and vegetation in the project area necessary for the roadway maintenance, parking area improvements, construction, and related work.

Clearing is cutting trees and brush so that stumps are no more than three inches above the ground. Grubbing is removal of stumps and roots at least twelve inches below finished grade.

3.2 - PROCEDURE

Review with PGC staff areas where clearing and grubbing will be necessary before commencing clearing and grubbing operations. Protect and do not damage any plants or trees, natural growth, or other objects outside the areas to be cleared and grubbed.

Cut down the trees and brush in the designated areas. Cut the trees and brush so that the stumps are no more than three inches above the ground. Stumps must also be removed from the areas designated to be grubbed and can be placed outside of the cartway limits.

Remove trees from road corridor as marked and directed by PGC staff. Remove stumps within the limits of the road cartway and as directed by PGC staff. Stumps beyond the limits of the road cartway and drainage ditches that will not impact the road maintenance and construction work can remain.

Tops and slash from removed trees will be cleared within 10 feet of the State Game Land boundary, roads and ditch lines, culverts, spring runs, and defined stream channels.

Cleared and grubbed material shall be placed at the project site as directed by PGC staff.

All merchantable logs must be removed from the site as directed by PGC staff.

Burning is not permitted at the site.

3.3 - MEASUREMENT AND PAYMENT

See Technical Specification Section 2 for description of pay items.

TECHNICAL SPECIFICATION SECTION NO. 4 - EXCAVATION

4.1- SCOPE

This work includes grading and other excavation activities to maintain the roadway, drainage features, and related work to re-establish and shape the road and parking area subgrade in preparation for resurfacing operations. Work includes but is not limited to removal, hauling, and disposal of all materials encountered for construction of the project as required and directed by PGC staff.

4.2 - PROCEDURE

A. General - Follow all guidelines set forth in the Construction Industry Standards, OSHA 2207, of the Occupational Safety and Health Administration, U.S. Department of Labor. Protect the work, adjacent roadways, and surrounding property.

The Contractor shall contact the PA One Call System at 1-800-242-1776 prior to excavation operations at the site.

The Contractor shall coordinate work and roadway alignment / corridor areas and layout start and end locations with PGC staff. Do not over-excavate - unauthorized excavation and replacement of materials in the over-excavated areas will not be measured and paid for. Replace over-excavated work with PennDOT Class A concrete, compacted 2A coarse aggregate, or compacted suitable fill material as determined by PGC staff at no additional cost to the Game Commission.

B. Excavation - Remove all materials to the limits required for the roadway work. All excavation work is considered unclassified and shall include the excavation of all materials encountered, including rock materials, regardless of their nature or the manner in which they are removed. No additional payment will be considered or paid for unsuitable material or rock excavation.

C. Disposal – Suitable excavated materials can be used for backfilling and grading at the site. Unsuitable materials and excess excavated material shall be disposed of on-site as directed by PGC staff.

4.3 - MEASUREMENT AND PAYMENT

None – No separate payment will be made for this item. This work shall be considered incidental to the other items of work in the project and included in the Bid and will not be measured and paid for separately.

TECHNICAL SPECIFICATION SECTION NO. 5 – ROAD SURFACE PREPARATION AND CONSTRUCTION

5.1- SCOPE

This work includes but is not limited to preparing the road and parking area subgrade by scarifying, grading, shaping, and compacting the scarified and graded material then resurfacing (surfacing) with coarse aggregate as specified herein and shown on the drawings / details.

5.2– MATERIALS

A. 3A Modified Coarse Aggregate – Shall be a mix of AASHTO #3 and suitable fine aggregates, limestone fines in an amount of 20% are blended with the material to provide a suitable compacted road base material.

3A Modified Coarse Aggregate provided on this project shall be crushed limestone. Sandstone 3A Coarse Aggregate is not acceptable.

B. AASHTO #1 Coarse Aggregate – Coarse aggregate for French Mattresses and Road Sub-base spot treatment shall be Type A quality conforming to the requirements of Section 703.2 of PennDOT Pub. 408. Coarse Aggregate provided on this project may be crushed limestone.

C. PENNDOT 2A Modified Coarse Aggregate - Shall be Type A quality conforming to the requirements of Section 703.2 of PennDOT Pub. 408. “Modified” is NOT an official specification, but the term is used by many municipalities and quarries. Modified is usually a 2A aggregate that has been “modified” with the addition of another aggregate, typically additional fine material to make a more well-graded aggregate.

PENNDOT 2A Coarse Aggregate for resurfacing the road and parking area shall be crushed limestone. Sandstone 2A Coarse Aggregate is not acceptable.

D. PENNDOT 2RC - Shall be Type A quality conforming to the requirements of Section 703.2 of PennDOT Pub. 408. A widely varying specification with a top size of 2” and few other restrictions. 2RC typically has an extremely high clay content and may contain soil and even organic components. May only be substituted on steeper grades to reduce the washboard potential. Use of this material will be at the discretion of the Regional Forester.

E. Aggregates provided for this project are not required to be “PennDOT Certified” or come from a source approved in PennDOT Bulletin 14 but shall meet all other requirements of PennDOT Pub. 408, Section 703.2 and are subject to pre-approval and on site approval by the Pennsylvania Game Commission outlined in Paragraph 5.3 – APPROVAL OF MATERIALS.

5.3 – APPROVAL OF MATERIALS

Submit gradation tests, certifications, and other documents to attest to the suitability of the aggregates to the Pennsylvania Game Commission (PGC) for review and approval. Representatives from the PGC will review the submittals and, if necessary, visit the quarry to review and approve the material. Do not order materials until final approval is received from the PGC.

5.4 - PROCEDURE

A. General – All work in this section shall be coordinated to provide the designed features of the new road surface as shown on the drawings / details and as directed by PGC staff.

B. Access Aprons – Create access aprons to transition the newly improved road to any existing roads. Coordinate these access areas in the field with PGC staff.

B. Project Layout – The project layout was prepared by PGC Regional Staff. Roadway construction operations are limited to the existing roadway alignment and corridor and as directed by PGC staff. A PGC representative will perform periodic site visits and inspections during construction to provide assistance and quality control.

C. Filling Potholes – Voids resulting from tree and stump removal or removal of large rocks shall be filled with on-site suitable excavated material. Compact the material with a vibratory plate compactor or similar equipment. Compaction of fill material will be considered adequate with no visible movement of material under compaction equipment and no rutting or displacement under vehicle loads.

D. Remove Organic Material – Scrape leaves, roots, grass, weeds, etc. off the surface of the road alignment. Spoil this material on site as directed by PGC staff.

E. Scarifying – Scarify the surface of the existing road to a minimum depth of two (2) inches to obtain material for grading and shaping the road.

F. Grading and Shaping – Grade and shape the roadway in accordance with the attached details and as directed by PGC staff to form the required road section shape and to provide an even surface for resurfacing operations.

G. Compaction – Compact the graded and shaped material with a 10-Ton (min.) single smooth drum vibratory roller.

H. Coarse Aggregate Material Road Section – Place Coarse Aggregate Material on the prepared subgrade. A paver may be used for road surface aggregate placement but is not required. Compact the coarse aggregate with a 10-Ton (min.) single smooth drum vibratory roller to a minimum compacted thickness as shown. Maintain the road shape, slope and profile during placement and compaction operations.

I. Road Base Repairs – Repair prepared and graded road subgrade and aggregate road base if it becomes damaged or rutted during subsequent construction operations. Re-grade and re-

compact subgrade and aggregate base as required prior to coarse aggregate road surface application. Any required repairs are incidental to the contract. No separate or additional payment will be made.

5.4 - MEASUREMENT AND PAYMENT

See Technical Specification Section 2 for description of pay items.

TECHNICAL SPECIFICATION SECTION NO. 6 – DRAIN PIPE

6.1 - SCOPE

This work is constructing drainage pipe as shown on the drawings / details.

6.2 – MATERIALS

- A. PennDOT 2A Coarse Aggregate** – Coarse aggregate for the pipe bedding and backfill shall be Type A quality conforming to the requirements of Section 703.2 of PennDOT Pub. 408. Coarse Aggregate provided on this project may be crushed limestone OR sandstone.

Aggregates provided for this project are not required to be “PennDOT Certified” or come from a source approved in PennDOT Bulletin 14 but shall meet all other requirements of PennDOT Pub. 408, Section 703.2 and are subject to pre-approval and on site approval by the Pennsylvania Game Commission outlined in Paragraph 6.3 – APPROVAL OF MATERIALS.

- B. R-4 RIPRAP** – Rock utilized for riprap shall be as specified in Section 850 of PennDOT Pub. 408. Rock shall come from material providing an approved Type A aggregate and from a source listed in PennDOT Bulletin 14. Provide riprap size as shown on drawings / details or as specified and directed by PGC staff. **R-3 RIP RAP provided on this project must be crushed limestone**

- C.** Unless otherwise specified or directed by PGC staff, coarse aggregate pipe backfill and riprap shall either be crushed limestone or limestone rock or sandstone / sandstone rock.

- D. Drain Pipe** (Size as indicated on maps, drawings / details, and specifications) – Drain pipe shall be high density polyethylene (HDPE) corrugated pipe conforming to the requirements of Section 601 of PennDOT Pub. 408. Pipe shall have a smooth interior and annular exterior corrugations. Pipe shall meet AASHTO M294, Type S or SP, ASTM F2306. Pipe joints shall be soil tight bell and spigot meeting the requirements of AASHTO M 294. Polyethylene shall conform with the minimum requirements of cell classification 435400C in accordance with ASTM D3350. Obtain the pipe from a source listed in PennDOT Bulletin 15.

6.3 – APPROVAL OF MATERIALS

Submit gradation tests, certifications, and other documents to attest to the suitability of the aggregates to the Pennsylvania Game Commission (PGC) for review and approval. Representatives from the PGC will review the submittals and, if necessary, visit the quarry to review and approve the material. Do not order materials until final approval is received from the PGC.

6.4 - PROCEDURE

- A. Coordinate with PGC staff and provide construction layout to determine elevations and set pipe inverts and slope to accommodate field conditions and provide positive drainage.
- B. Provide drain pipes at locations designated by PGC staff.
- C. Construct drainage pipe in the dry in non-flow conditions. The culverts shall be installed as shallow as possible with fill used in the approaches to help create grade breaks in the roadway. Excavate to the required depth, length and shape as shown on the details. Install pipe in accordance with manufacturer's written instructions. Provide coarse aggregate pipe bedding compacted in 6-inch lifts with a stand-up hand operated or walk behind vibratory compactor to 12" above top of pipe. Backfill remaining trench with suitable excavated material and/or required roadway materials. Compaction of pipe bedding will be considered adequate with no visible movement of material under compaction equipment and no rutting or displacement under vehicle loads.
- D. Extend tail ditches from pipe discharge as required to provide free drainage and allow positive gravity flow of water away from the roadway (daylight).
- E. Existing culvert pipes removed during construction shall be removed from PGC property and properly disposed of.
- F. R-4 riprap discharge aprons shall be provided and placed in the tail ditch at culvert pipe outlets. The riprap apron shall be 4-feet wide by 10-feet long by 1-foot thick. **(NOTE: Provide aprons if specified and shown on drawings / details and/or itemized on Bid Form).**

6.5 - MEASUREMENT AND PAYMENT

See Technical Specification Section 2 for description of pay items.

TECHNICAL SPECIFICATION SECTION NO. 7 – STONE HEADWALLS

7.1 - SCOPE

This work is for constructing stone headwalls for the drainage pipes to meet current recommendations referenced by attached Technical Bulletin from Penn State Center for Dirt and Gravel Road Studies Stacked Stone Headwalls.

7.2 - MATERIALS

Headwall stone should be a minimum 12 inches by 12 inches wide by 2 inches thick. Stone material may be found onsite. If acceptable headwall stone is not available onsite, the stone will need to be supplied by the contractor.

7.3 - PROCEDURE

- A.** Provide headwall stone (inlet and outlet) w/ bank walls (if required) at all cross drain locations.
- B.** Excavate the inlets and outlets of the new drainage pipe at the proper locations. Prepare the subgrade for the headwalls on both ends of the drainage pipes. The PGC recommend placing a small amount of #2A coarse aggregate on the subgrade so that the headwalls can be placed level and stable.
- C.** Headwall bases should be 2-3 times the culvert pipe diameter, on the inlet side, the face should be sloped or canted back toward the road surface, seams of the placed stoned should be overlapped like bricks, and stone should be placed under and on top of the culvert.
- D.** Complete the backfill of the drainage pipes to lock the stone headwalls in place.

7.4 - MEASUREMENT AND PAYMENT

See Technical Specification Section 2 for description of pay items.

TECHNICAL SPECIFICATION SECTION NO. 8 – FRENCH MATTRESS

8.1 - SCOPE

This work is constructing a French Mattress as shown on the drawings / details.

8.2 – MATERIALS

A. GEOTEXTILE FABRIC –Provide Class 1 non-woven Geotextile fabric minimum of 11 ounce material.

A. AASHTO #1 Coarse Aggregate – Coarse aggregate for the French Mattress Shall be Type A quality conforming to the requirements of Section 703.2 of PennDOT Pub. 409. Coarse Aggregate provided on this project must be crushed limestone.

Aggregates provided for this project are not required to be “PennDOT Certified” or come from a source approved in PennDOT Bulletin 14 but shall meet all other requirements of PennDOT Pub. 409, Section 703.2 and are subject to pre-approval and on site approval by the Pennsylvania Game Commission outlined in Paragraph 8.3 – APPROVAL OF MATERIALS.

B. Unless otherwise specified or directed by PGC staff, coarse aggregate shall either be crushed limestone or limestone rock or sandstone / sandstone rock.

8.3 – APPROVAL OF MATERIALS

Submit gradation tests, certifications, and other documents to attest to the suitability of the aggregates to the Pennsylvania Game Commission (PGC) for review and approval. Representatives from the PGC will review the submittals and, if necessary, visit the quarry to review and approve the material. Do not order materials until final approval is received from the PGC.

8.4 - PROCEDURE

A. Coordinate with PGC staff and provide construction layout to determine elevations and set inverts and slope to accommodate field conditions and provide positive drainage.

B. Provide the French Mattress at a location designated by PGC staff.

C. Construct in the dry, non-flow conditions. Excavate to the minimum required trench depth of three (3) feet and a width of specified in the Scope of Work, by the width of the road (18’ ditch to ditch) and shape as shown on the details. Allow for a minimum 12 inches of compacted cover over the mattress.

- D.** Provide Class 1 Non-woven Geotextile fabric to wrap and overlap the stone to create the mattress.
- E.** Provide and place AASHTO #1 Coarse Aggregate on top of the fabric and spread into a uniform bed of the desired depth.
- F.** Shape and compact fill overtop the finished mattress. Establish the desired road surface shape and compact with a min 10-ton vibratory roller.
- G.** Extend tail ditches from discharge as required to provide free drainage and allow positive gravity flow of water away from the roadway.

8.5 - MEASUREMENT AND PAYMENT

See Technical Specification Section 2 for description of pay items.

TECHNICAL SPECIFICATION SECTION 9 - EROSION AND SEDIMENTATION CONTROL

9.1 -SCOPE

This work consists of implementing the soil erosion and sedimentation (E&S) control measures contained on the specifications, drawings / details, and described herein. E&S control measures shall be implemented in accordance with the provisions of the Clean Streams Law and 25 Pennsylvania Code Chapter 102. The Pennsylvania Department of Environmental Protection Erosion and Sediment Program Pollution Control Manual as well as the Commonwealth of Pennsylvania Department of Transportation Publication 408 and the PSU Center for Dirt and Gravel Road Studies Technical Bulletins and Standard Detail Sheets are the sources for the construction items described and referenced herein and incorporated into this plan.

9.2 – ATTACHED REFERENCE

PA DEP *“Erosion and Sediment Control (E & S) Plan Template for a Timber Harvesting Operation”* prepared for this project (included with specifications / Bid Documents).

9.3 – PROCEDURE

A. Project Description – See Project Summary and related Erosion and Sedimentation Control plan specifications and drawings / details included with the Contract Documents as well as supplemental information and requirements provided by PGC staff.

This Soil Erosion and Sedimentation Control Plan is designed to control soil erosion at its source and to prevent runoff flows from carrying sediment beyond the work area limits. The Contractor is responsible for the implementation and execution of this plan and for providing and maintaining proper soil erosion and sedimentation controls during the duration of the project until permanent stabilization conditions are achieved.

B. Stormwater Runoff and Drainage – The project site(s) consist of access / administrative road corridors on undeveloped, rural, forested PGC State Game Lands. Post construction runoff will reach existing drainage features and surface waters by way of overland flow consistent with existing conditions. Existing storm water flow at the individual sites will not be substantially altered as a result of the project. Existing drainage features or facilities disturbed during construction shall be repaired or reconstructed by the Contractor.

Construction details are included with or referenced in the Contract Documents. The roadway and adjacent areas shall be graded as needed to provide the desired road cross section and suit existing site conditions and requirements for access; however, finished contours for the affected adjacent areas will not be substantially different than existing. Roadway surfaces will be surfaced and stabilized with coarse aggregate. All other disturbed areas will be restored to their pre-construction conditions with seed and mulch.

Drainage from the project site flows to Sugar Run (Chapter 93 designation: CWF) and an unnamed tributary of the Conemaugh River.

- C. Soils Information / Limitations** - Soils information for the project is available from the U.S.D.A. Natural Resources Conservation Service soil survey for Pennsylvania. Soils information is included in the attached E & S Plan Template.

Subsurface conditions from the NRCS Soil Survey have not been verified in the field by the PGC.

The Contractor shall provide appropriate excavation equipment and construction techniques to conduct earthwork operations required for the project.

Unsuitable materials shall be separated from fill material prior to placing and compacting embankment fill.

- D. Hydrology and Hydraulics** - Construction will not significantly affect the overall hydrology of the project sites. Vegetation clearing and grubbing and grading work will be required for construction. Roadways will be stabilized with aggregate and all other disturbed areas and pre-construction drainage patterns will be restored after the construction activities have ended.

The Contractor shall provide and maintain E&S controls during construction as described herein and shown on the details to minimize the impact of runoff during rainfall events. Once the temporary impacts of construction have ended, the pre-existing hydrology will be re-established.

E. Erosion Control Measures -

1. General

- a.) Accelerated erosion control shall be accomplished through the rapid stabilization of all disturbed surfaces throughout the project area, use of Best Management Practices (BMPs), and precautions in the use of construction equipment.
- b.) During the earth disturbance activity, precautions must be taken to prevent accelerated erosion, minimize damage, injury or destruction of property; prevent pollution; protect natural vegetation not targeted for removal during the activity/project; and protect natural drainage ways and surface waters. All disturbed areas shall be stabilized immediately.
- c.) The Contractor shall provide temporary erosion control measures as required and site conditions dictate to reduce the erosion potential of the site. Compost Filter Sock shall be provided as needed in accordance with the attached details and as directed by PGC staff.

2. Temporary Stabilization

- a.) Provide temporary stabilization of disturbed areas as shown on the details.

- b.) At a minimum, all disturbed areas shall be temporarily restored and stabilized (mulched) within 4 days of the disturbance. Seed mixture and application rates are included in the specifications.

C. Permanent Stabilization

- a.) Permanent seeding and soil supplements shall be provided on disturbed and final graded areas during the germinating season as soon as practical but not than 15 days after disturbance. Seeding and mulching shall be provided as specified herein and as shown on the drawings / details.
- b.) Provide permanent stabilization of disturbed areas as specified herein.
- c.) The project area will be considered permanently stabilized when all permanent control measures/facilities have been completed and are operational, all temporary control measures/facilities removed, and a minimum uniform 70% perennial vegetative cover, with a density capable of resisting accelerated erosion and sedimentation is established.

D. Maintenance

- a.) Maintain temporary control measures and facilities as shown on the details.
- b.) Sediment accumulation shall be removed and disposed of at approved locations. These locations shall be selected such that the sediment will not erode into the construction area or any natural waterway.
- c.) Stabilized coarse aggregate (stone or gravel) surfaces that become eroded shall be restored with additional coarse aggregate materials.
- d.) Any permanent seeded areas that become eroded shall be repaired / regraded, seeded, and new mulch applied.
- e.) If the vegetative cover deteriorates and becomes ineffective, a fertilization and re-seeding program shall be established and carried out as the construction proceeds. Areas where failures have been experienced in the establishment of both permanent and temporary vegetative protection shall be promptly treated. Re-establishment of permanent vegetative cover shall be initiated as soon as possible.
- f.) After permanent site stabilization has been achieved, temporary erosion and sedimentation controls must be removed. Areas disturbed during removal of the control must be stabilized immediately. Re-grade areas as needed and seed and mulch using the permanent seeding schedule as indicated.

F. Recycling and Disposal of Construction Materials - All construction materials, including soils and aggregates, should be recycled and/or re-used to the greatest extent possible at the Project Site. Woody vegetation waste materials should be shredded/chipped for use on-site as mulch materials if possible or as directed by PGC staff. Other debris and other construction by-products, including waste pipe / fitting materials, metal, paper, plastic, cardboard, batteries, rubber, etc. shall be properly disposed of at a local recycling center or waste transfer/landfill site. The Contractor shall not disposal of waste materials on-site via burning or burial.

- G. Waste Disposal Sites** - Excess excavated material shall be properly and legally disposed of off-site or as directed by the PGC. The contractor shall provide appropriate soil erosion and sedimentation controls for the waste sites and they shall be stabilized. Provision of E&S controls at disposal sites is considered incidental to construction.

- H.** Failure to implement soil erosion and sediment pollution control measures may result in a cease and desist order, causing shutdown of the work. No extension of time, nor additional compensation will be granted if such a shutdown should occur as a result of act or neglect of the Contractor.

9.4 - MEASUREMENT AND PAYMENT

See Technical Specification Section 2 for description of pay items.

TECHNICAL SPECIFICATION SECTION 10 - RESTORATION

10.1 - SCOPE

This work is securing a satisfactory stand of grass and permanent stabilization at disturbed areas or where directed by the PGC, and includes preparation of the seed bed, furnishing and placing lime and fertilizer, furnishing and sowing of seed, mulching, and maintaining and tending the seeded areas.

10.2 - APPLICABLE PUBLICATIONS AND REFERENCES

Bulletin 15 - Approved Construction Materials, Pennsylvania Department of Transportation.
Publication 408 - Specifications, Pennsylvania Department of Transportation.

10.3 - MATERIALS

A - Grass Seed – As shown and specified below. Other similar mixes may be proposed subject to the approval of PGC staff and provided proposed mixes provide effective stabilization and protection against accelerated erosion, promote improved wildlife habitat, and are consistent with the project requirements and PGC wildlife habitat management best practices. [NOTE: Disregard seed mixes recommended in the “*Erosion and Sediment Control (E & S) Plan Template for a Timber Harvesting Operation*” document included in the specifications. Provide the seed mix specified below OR an alternate mix as directed and approved by PGC staff.]

**NATIVE SEED MIX FOR DISTURBED AREA RESTORATION
ON STATE GAME LANDS**

Timothy (Phleum pratense)	5 lbs/acre
Birds foot trefoil (Lotus corniculatus)	5 lbs/acre
Little bluestem (Schizachyrium scoparium)	3 lbs/acre
Side oats grama (Bouteloula curtipendula)	1 lbs/acre
Black-eyed susan (Rudbeckia hirta)	0.25 lbs/acre
Lance-leaved coreopsis	0.25 lbs/acre
Cover crop – Oats (Avena fatua) (spring) or Winter wheat (Fall)	30 lbs/acre
TOTAL	44.5 lbs/acre
Straw Mulch	3 Tons / acre

**** ALL QUANTITIES (WHERE APPLICABLE) ARE BASED ON PURE LIVE SEED (PLS)**

Seed mixes **SHALL NOT** include annual or perennial rye, wildrye, or fescue variety grass seeds.

Deliver premixed seed in bags or other suitable containers, each fully labeled with the name, trademark, and warranty of the producer and with the mixture type, weed seed percentage, purity percentage, germination percentage, and mix formula or composition.

Do not use seed which has become wet, moldy, or otherwise damaged in transit or storage, has a mix date older than 11 months prior to seeding, or has a test date older than 6 months prior to seeding.

B - Fertilizer – If required and specified, use dry formulation of 10-20-20-analysis. Fertilizer shall be delivered in bags or other suitable containers, each fully labeled and bearing the name, trademark, and warranty of the producer.

C - Lime - If required and specified, lime application shall conform to Section 804.2(a).1 of Pub.408.

D – Inoculant – If required and specified, provide in accordance with Section 804.2(c) of Pub. 408.

E - Mulches - Mulches shall be free from mature seedbearing stalks or roots of prohibited or noxious weeds as defined by law. Do not use mulches which are cut into lengths of less than 6 inches.

Mulches shall be either one or a combination of the following, shall contain no stems of tobacco, soybeans, or other coarse or woody materials.

1. - Straw - Either wheat or oat straw, and free of weeds and viable seeds, well-cured to less than 20 percent moisture content by weight, not chopped or finely broken.

2. - Wood Fiber - Use wood fiber meeting the requirements of Section 805.2(a).1.c of Pub. 408.

3. - Pellet Mulch - Use pellet mulch meeting the requirements of Section 805.2(a).1.d of Pub. 408.

F - Mulch Binders - Use one of the following mulch binders in accordance with Section 805.2(b) of Pub. 408. Use Recycled Cellulose Fiber, Wood Fiber, Non-asphaltic Emulsion, Polyvinyl Acetate, or a Mixture of Recycled Cellulose Wood Fiber and Wood Fiber. Obtain binders from a producer listed in Bulletin 15.

G - Water - Water shall be fresh and free from injurious amounts of oil, acid, alkali, salts, or other materials harmful to the growth of grass.

H – Topsoil - Acceptable friable loam that is reasonably free of subsoil, clay lumps, brush, roots, weeds, other objectionable vegetation, stones, other foreign material larger than 2 inches

in any dimension, litter, and/or other material unsuitable or harmful to plant growth in accordance with Section 801.2 (a) and 802.2 of Pub. 408.

10.4 - PROCEDURE

Follow the procedures specified below and as listed in Section 804.3 of Pub. 408. The amounts of seed, lime, fertilizer, and mulch specified are the minimum acceptable. Employ modifications if they are deemed necessary, at no additional cost to the PGC, and accept full responsibility for obtaining a satisfactory stand of grass.

A – Topsoil Furnished and Placed – Reference Section 802 of Pub. 408. Provide topsoil as shown on the drawings / details and as required to restore disturbed areas. Grade the areas to be covered by topsoil. Using acceptable methods, loosen soil to a depth of 2 inches before placing the topsoil. Remove stones and other foreign material 2 inches or larger in any dimension. Remove and satisfactorily dispose of unsuitable and surplus material. Place topsoil on the prepared areas and, unless otherwise indicated, spread and compact to a 4-inch uniform depth $\pm 1 \frac{1}{2}$ inches. Compact with a roller having a weight not over 120 pounds per foot width of roller or by other acceptable methods, as directed. Remove over-depth topsoil, unless otherwise agreed upon in writing. Do not place topsoil in a wet or frozen condition.

B - Sowing - Sow the seed mixture on a still day at a rate specified in Section 804.2 of Pub. 408. Sow by hand or by approved sowing equipment in 2 applications, one-half the seed while the seeder is traveling in one direction and the other half while the seeder is traveling at right angle to the first direction. After sowing, rake, cultipack, or brush drag the surface very lightly, just deep enough to cover the seeds. Rake only in a direction parallel to the contour lines.

C - Mulching - After sowing is completed, spread mulch uniformly over the entire seeded area at a rate of 3 tons (dry weight) per acre. The mulch shall be moist at the time of placement.

Apply wood fiber mulch hydraulically in accordance with the manufacturer's tank-mixing instructions. Wood fiber mulch may be incorporated into the slurry after the seed and soil supplements have been thoroughly mixed. Apply wood fiber mulch at a rate of 800 Lbs. per acre unless otherwise indicated by the manufacturer.

On slopes 6:1 or flatter, apply pellet mulch by hand or using a mechanical spreader immediately after seeding, at a rate of 2,615 Lbs. per acre. Thoroughly wet pellet mulch with water without dislodging mulch.

To prevent loss or bunching by wind and to form a soil-binding mulch, anchor the moist mulch to the soil with a mulch binder. Use mulch binders at the following rates:

Recycled Cellulose Fiber - 775 Lbs./Acre

Wood Fiber - 775 Lbs./Acre

Mixture of Recycled Cellulose Fiber and Wood Fiber - 775 Lbs./Acre

Non-asphaltic Emulsion - Manufacturer's Recommended Rate

Polyvinyl Acetate - Manufacturer's Recommended Rate

On slopes where machinery cannot be used, retain the mulch in place by some suitable means which will not be detrimental to subsequent operations.

10.5 - MAINTENANCE

At no additional cost to the PGC, maintain the seeded areas until all work under the Contract has been completed and accepted by the PGC. Maintenance shall include refilling rain-washed gullies, reseeding, reapplying fertilizer, lime and mulch, and removal of large and noxious weeds, as directed by the PGC.

10.6 - MEASUREMENT AND PAYMENT

See Technical Specification Section 2 for description of pay items.



Erosion and Sediment Control (E&S) Plan Template for a Timber Harvesting Operation

This E&S Plan template only applies to timber harvest activities, as defined by 25 Pa. Code §102.1, which are not part of a larger development or conversion project.

1. GENERAL INFORMATION

1/23/2024 _____
Date

A. Location Georges Township _____
Municipality

Fayette _____
County

B. Timber sale area = 4__ acres

C. Landowner/Agent Pennsylvania Game Commission _____
Name

_____ 714-238-9523_
Home Phone Work Phone

4820 Route 711 _____
Street Address

Bolivar _____ PA _____ 15923 _____
City State Zip Code

Signature of Landowner/Agent

D. Person(s) responsible for construction and maintenance of erosion and sediment control BMPs during and after earth disturbance activities.

(NOTE: If duties are assigned to more than one party, list all others under Section 12 of this plan.)

Name

Home Phone Work Phone

Street Address

City State Zip Code

Signature of person(s) responsible

E. Erosion and Sediment Control Plan prepared by:

Neil J. Itle _____
Name

Phone 724-239-9523 _____

482 Route 711 _____
Street Address

Bolivar _____ PA _____ 15923 _____
City State Zip Code

Signature of Plan Preparer

2. TOPOGRAPHICAL MAP

The map must include the location of the project with respect to roadways, streams, wetlands, lakes, ponds, floodplains, type and extent of vegetation and other identifiable landmarks. A United States Geologic Service (USGS) quadrangle map may be used to show the existing topographical features of the project site and the immediate surrounding area. The map scale must be large enough to clearly depict the topographical features of the project. Enlargements of the USGS quadrangle map are sufficient. The scale and north arrow must be plainly marked. A complete legend of all symbols used on the map must also be included.

3. SOIL MAP

Soils information is available in soil survey reports or online at <https://websoilsurvey.nrcs.usda.gov/app/>. For additional information, contact your local county conservation district office. The soils drainage classes must be examined to determine areas with the best drainage for the placement of haul roads and log landings, and to determine proper retirement treatments. Provide the following soils information for all disturbed areas.

Limiting Characteristics¹

**That May Apply to Timber Harvesting Activities
(Check as Appropriate)**

Map Symbols	Soil Series	Erosion Hazards ²		
		Slight	Moderate, severe	Seasonably Wet ³
HxB	Hazleton-Clymer complex, 0 to 8 percent slopes, extremely ston	<input checked="" type="checkbox"/>	<input type="checkbox"/>	<input type="checkbox"/>
HxD	Hazleton-Clymer complex, 8 to 25 percent slopes, extremely stony	<input checked="" type="checkbox"/>	<input type="checkbox"/>	<input type="checkbox"/>
HaB	Hazleton channery sandy loam, 3 to 8 percent slopes	<input checked="" type="checkbox"/>	<input type="checkbox"/>	<input type="checkbox"/>
LaD	Laidig gravelly loam, 8 to 25 percent slopes, extremely stony	<input checked="" type="checkbox"/>	<input type="checkbox"/>	<input type="checkbox"/>
CmB	Clymer channery loam, 3 to 8 percent slopes	<input checked="" type="checkbox"/>	<input type="checkbox"/>	<input type="checkbox"/>

¹Soils with a moderate or severe erosion hazard or are seasonably wet are poor choices for log landing and road locations, and, if possible, alternatives should be considered.

²The degree or ease by which soil particles can be detached from the soil surface. Moderate or severe ratings require additional consideration of soil erosion and sediment control BMPs during logging and road construction.

³Somewhat poorly drained soils remain wet for a longer period after rain and would be susceptible to disturbance. These soils may be hydric, indicating a possible wetland. They may have to be logged during dry seasons, when the profile may be relatively dry, or when the soils are frozen. They are poor choices for log landing and road locations, and, if possible, alternate areas should be considered.

4. SKETCH MAP

The characteristics of the earth disturbance activity. Sketch maps can be included on the topo map in Section 2. The limits of the harvesting area must be shown on the sketch map. Such information as the limits of clearing and grubbing and the areas of cuts and fills for roads and landings, and other proposed disturbances for the timber harvesting area are to be included. Earth disturbances located within a floodway (as defined by a FEMA map, or 50 ft. where not defined) may require a Chapter 105 permit. The following should be clearly shown on the sketch map:

- Project Boundary
- Stream Crossings
- Existing Roads
- Equipment Maintenance/Fueling Areas
- Wetland Crossings
- Landings
- Skid Roads
- North Arrow
- Haul Roads
- Section 8 BMPs

5. RECEIVING SURFACE WATERS

All streams in Pennsylvania are classified based upon their designated and existing uses and water quality criteria. Designated uses for waters of this Commonwealth are found in 25 Pa. Code §§ 93.9a-z, found online at <http://www.pacode.com/secure/data/025/chapter93/chap93toc.html>. Existing uses of waters of this Commonwealth are found DEP's website (www.dep.pa.gov), Keyword Search: Statewide Existing Use. The county conservation district office can also supply this information. Identify the surface waters, including wetlands, likely to receive direct runoff within or from the timber harvest area:

<u>Name</u>	<u>Designated/Existing Use</u>
Un-named Tributary to Georges Creek	WWF

Has application been made for required Chapter 105 permits? Yes No Not Applicable

At all stream crossing locations, runoff must be directed to a sediment removal area (e.g. filter strip, straw bale, silt fence, sump, or trap for treatment). Waterbars and/or broad-based dips should be installed and maintained as required on the approaches to the stream crossing.

6. ESTIMATED DISTURBED AREA

	Total Length (ft)	x	Average Width (ft)	=	Area (sq ft)	
Haul Roads	6,145	x	30	=	184,350	
Skid Roads	<hr/>	x	<hr/>	=	<hr/>	
Landings	<hr/>	x	<hr/>	=	<hr/>	
Total Area (sq. ft.)				=	184,350	÷ 43,560 sq ft/ac = 4.2
						*** Acres disturbed by earth disturbance activities

*** If the total area of earth disturbance activities (sum of area disturbed by haul roads, skid roads and landings) consists of 25 acres or more, a Chapter 102 Erosion and Sediment Control Permit (ESCP) must be obtained. Please contact the Department or authorized conservation district for assistance.

The following points should be considered when laying out a road system:

- **Construct only as much road as necessary.** Minimize clearing. Keep road width to the minimum necessary for safe and efficient operation.
- **Terminal points** – Locate the start and end of the road system using the best access that is safe and visible from public roads. Locate landings away from streams and wet areas. Install rock construction entrances as shown in Section 8.K. **NOTE: A highway occupancy permit may be required.**
- **Grades** – Haul roads with a maximum slope of 10% and a minimum of 2% are usually the easiest to maintain. Where absolutely necessary, grades of 15 to 20% can be used for short distances. Follow the contour as much as possible. Use waterbars (Section 8.B) on skid roads whenever it is not possible to avoid grades of 20% or more.
- **Topography** – Roads on moderate side hills are easiest to build and maintain. Avoid steep slopes wherever possible.
- **Drainage** – Construct roads to drain at all times, such as using crowned or insloped surfaces. Install ditch relief culverts as shown in Section 8.A or broad-based dips as shown in Section 8.E. Turnouts as shown in Section 8.C may be used on low-side ditches to direct flow into filter strips.
- **Grading** – Minimize cut and fill work, and keep slopes at stable angles. Remove trees from tops of cuts, when the root system is undercut, and seed and mulch cut and fill slopes promptly (Section 8.L). Do not fill into open sinkholes, waterways, wetlands, floodways or other sensitive areas.
- **Obstacles** – Design the road system to go around springs, seeps, wetlands, poor drainage areas, ledges, and rocky areas wherever possible.
- **Distances from Streams** – Filter strips should be maintained along stream corridors to provide sediment filtration and maintain stream temperatures (Section 8.F). Wherever sufficient filter strips are not possible between roadways and receiving surface waters, install BMPs, such as silt fence (Section 8.G) as the roadway progresses. See Section 8.F for minimum filter strip widths.
- **Stream Crossings** – Minimize the number of stream crossings. Cross at a 90 degree angle and approach the stream at as gentle a slope as possible. **NOTE: A Chapter 105 permit may be required.**

- **Old roads** – It is often possible to use existing roads and thereby lessen the soil disturbance. However, to avoid problems, carefully evaluate the road's suitability for upgrading.
- **Landings** – Locate landings in relation to the main haul road. Then lay out the skid road and trail approaches on a low grade to the landings. Minimize the number and size of landings as much as possible.
- **Size and duration of sale** and the anticipated season of harvest.
- **Floodways and wetlands** – Avoid encroaching on wetlands. Roadway and landing construction within floodways and wetlands may require Chapter 105 permits.
- **Water Control Structures** – Carefully plan the use of broad based dips (Section 8.E), waterbars (Section 8.B), culverts (Section 8.8A), and ditches to maintain existing flow patterns and minimize the amount of runoff being conveyed by roadways and roadside ditches.
- **NEVER SKID THROUGH OR ACROSS STREAM CHANNELS AND AVOID WETLANDS, SPRINGS OR SEEPS.**

7. RUNOFF

The amount of runoff from the timber harvest area and its upstream watershed area. You do not have to provide runoff calculations, unless you plan to use BMPs different from those described in Section 8. If you use different BMPs, your calculations must include an analysis showing any impact that runoff may have on existing downstream watercourses and their resistance to erosion.

8. DESCRIPTION OF EROSION AND SEDIMENT CONTROL MEASURES

The following standard BMP drawings and recommended spacings (Sections 8.A-8.L) have been provided to fulfill the requirements of this plan and satisfy Chapter 102 regulations. If you plan to use any of these recommended BMPs, please check the appropriate boxes for Sections A through L and include their location on the sketch map (Section 4). If you plan to use alternative BMPs, you must provide drawings showing the details, specifications and spacing (Section 7). The standards and construction details referenced are from the Department's *Erosion and Sediment Pollution Control Program Manual* (Document #363-2134-008, March 2012). Additional approved BMPs and specifications can be found at DEP's website, Keyword Search: E&S Resources.

Timber harvesting projects that require a Chapter 102 ESCP and occur within a special protection watershed or EV wetland will be required to implement nondischarge alternatives and antidegradation best available combination of technologies (ABACT) BMPs. Refer to Chapter 17 of the *Erosion and Sediment Pollution Control Program Manual* for more information.

A. Ditch Relief Culvert (Cross Drains)

Design Standards

- Minimum diameter for any culvert is 12"; otherwise culvert shall be sized for anticipated peak flow. Place culvert so bottom is at same level as bottom of ditch or adjoining slope. Culverts shall be placed with a slope of 2 to 4%. Lower end shall be at least 2" below upper end and at ground level.
- Extend culvert 12" beyond base of road fill on both sides. Firmly pack fill around culvert, especially the bottom half.
- Provide suitable outlet protection and, where appropriate, inlet protection.
- NOTE: This detail may be used for ditch relief culverts and for crossings of roadside ditches. It is not appropriate for stream crossings.
- For steep slope (>2H:1V) outfalls, a minimum 20 foot long R-5 apron is recommended for temporary access roads where the recommended culvert spacing is used. For permanent access roads, a minimum R-6 rock size is recommended.

Maintenance

- Inspect culvert(s) weekly: remove any flow obstructions and make necessary repairs immediately.

Will this BMP be used? Yes No

Will recommended spacing be used? Yes No

Table 1. Ditch relief culvert spacing for temporary access roads

Road Grade (% Slope)	Recommended Spacing (ft)	Alternative Spacing (ft)*
2	300	_____
3	235	_____
4	200	_____
5	180	_____
6	165	_____
7	155	_____
8	150	_____
9	145	_____
10	140	_____
12	135	_____

* If alternative spacings are used, please make sure reasons for their use are explained.

Table 2. Ditch relief culvert spacing for permanent access roads

Road Grade (% Slope)	Recommended Spacing (ft)	Alternative Spacing (ft)*
2	500	_____
4	400	_____
6	350	_____
8	300	_____
10	250	_____
12	200	_____
14	150	_____

* If alternative spacings are used, please make sure reasons for their use are explained.

Figure 1. Standard Construction Detail for Ditch Relief Culverts

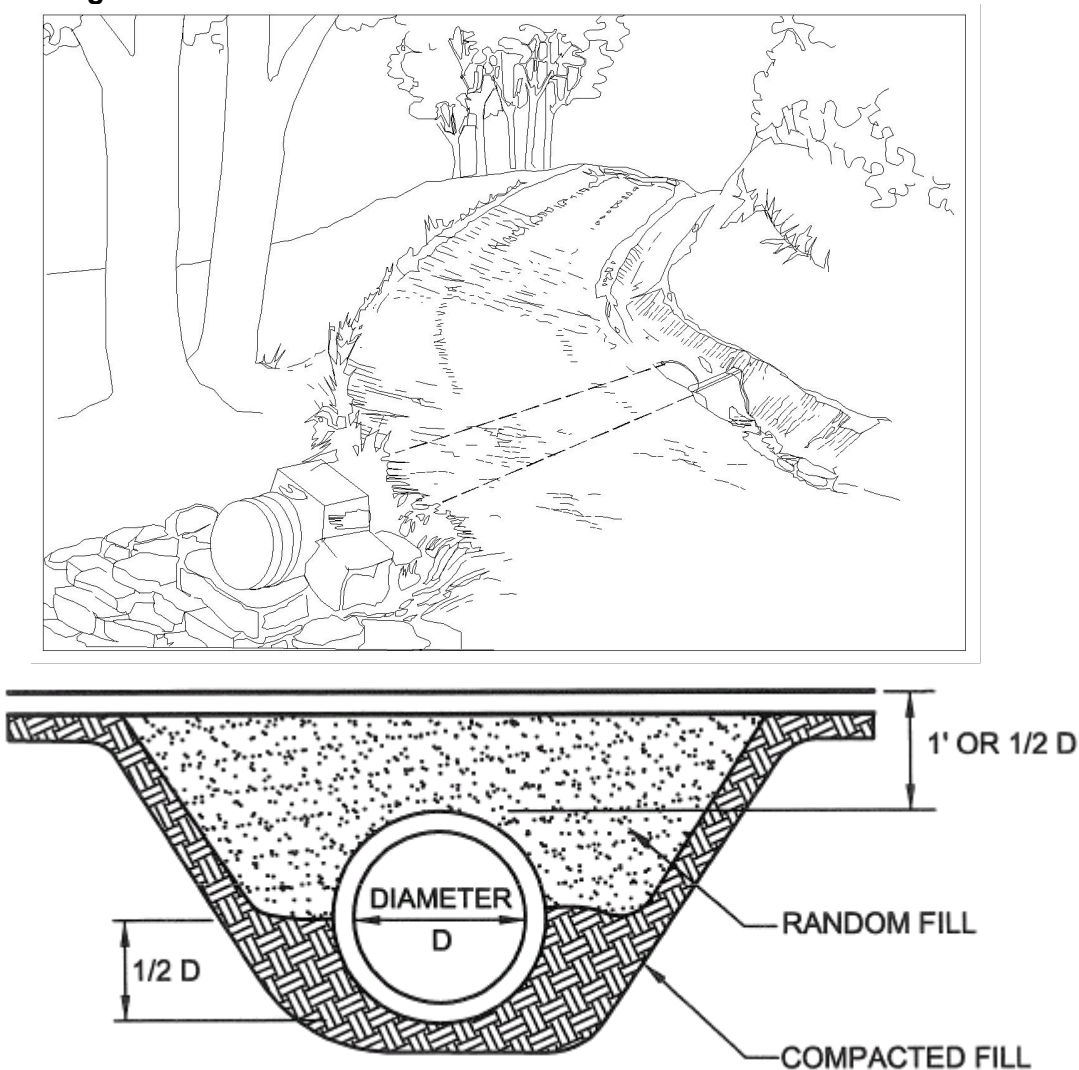

B. Waterbars

Design Standards

- Waterbars are typically used to control stormwater runoff on retired access roads and skid trails. They are not recommended for active access roads or skid trails due to the difficulty of moving equipment over them as well as the need for continual maintenance due to damage from traffic.
- Where waterbars are not practical on active access roads or skid trails, other BMPs such as Water Deflectors (Section 8.D) or Broad-based Dips (Section 8.E) can be used to control runoff.
- Waterbars shall be placed at a slight angle to allow drainage and discharge to a stable area.

Maintenance

- Waterbars shall be inspected weekly (daily on active roads) and after each runoff event. Damaged or eroded waterbars shall be restored to original dimensions within 24 hours of inspection.
- Maintenance of waterbars shall be provided until roadway, skid road, or right-of-way has achieved permanent stabilization.
- Waterbars on retired roadways, skid roads, and right-of-ways shall be left in place after permanent stabilization has been achieved.
- Waterbars that need to be removed during operations should be replaced before leaving the site at the end of the day.

Will this BMP be used? Yes No

Will recommended spacing be used? Yes No

Table 3. Waterbar spacing

Road Grade (% Slope)	Recommended Spacing (ft)	Alternative Spacing (ft)*
0 – 5	250	_____
5 – 15	150	_____
15 – 30	100	_____
30 & above	50	_____

* If alternative spacings are used, please make sure reasons for their use are explained.

Figure 2. Standard Construction Detail for Waterbars

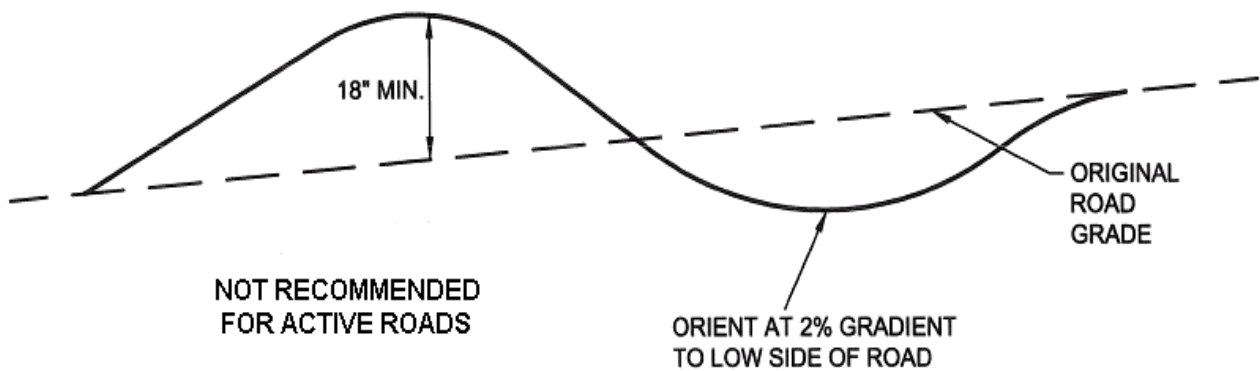
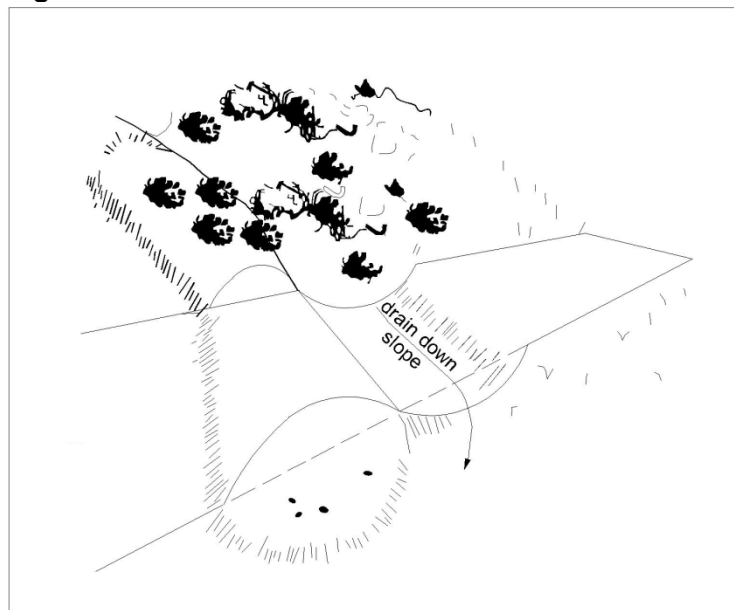

C. Turnouts

Design Standards

- Turnouts should be located so as to take advantage of natural drainage courses or filter strips whenever possible.
- An excavated sump at the end of the turnout can be effectively used to pond and settle out sediment prior to discharging to a vegetated buffer.
- Where a suitable filter strip is not available, a compost filter sock, rock filter or other sediment removal BMP should be installed at the outlet of the turnout.

Will this BMP be used? Yes No

Figure 3. Standard Construction Detail for Turnouts

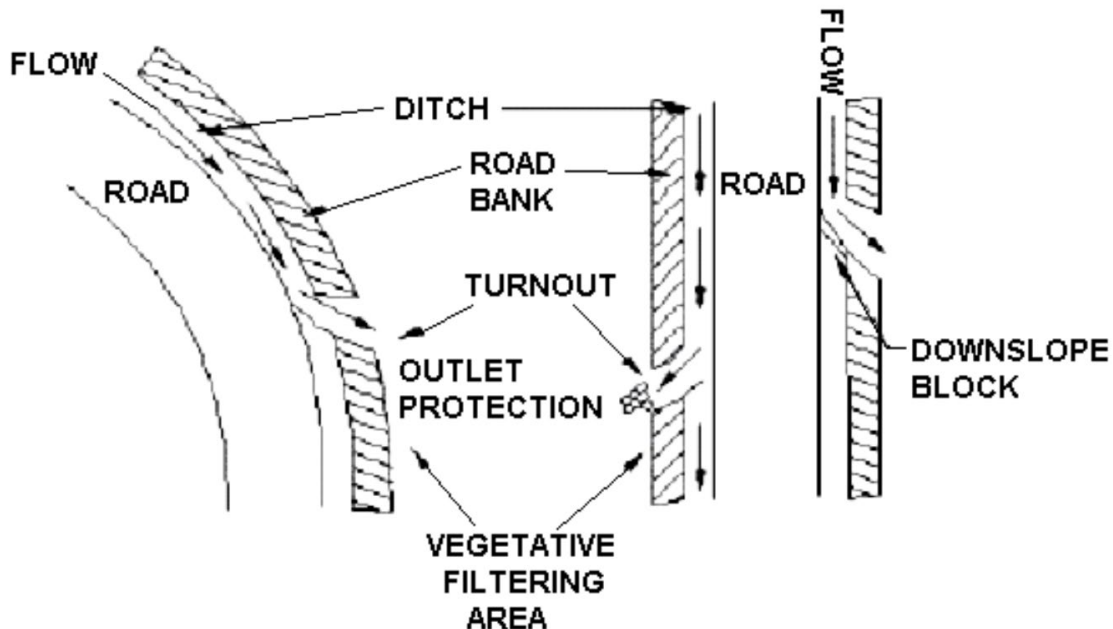

D. Water Deflector

Design Standards

- Maximum spacing of deflectors shall be as shown in Table 4.

Maintenance

- Deflector shall be inspected weekly and after each runoff event.
- Accumulated sediment shall be removed from the deflector within 24 hours of inspection.
- Belt shall be replaced when worn and no longer effective.

Will this BMP be used? Yes No

Will recommended spacing be used? Yes No

Table 4. Water Deflector Spacing

Road Grade (% Slope)	Recommended Spacing (ft)	Alternative Spacing (ft)*
< 2	300	_____
3	235	_____
4	200	_____
5	180	_____
6	165	_____
7	155	_____
8	150	_____
9	145	_____
10	140	_____

* If alternative spacings are used, please make sure reasons for their use are explained.

Figure 4. Standard Construction Detail for Water Deflectors

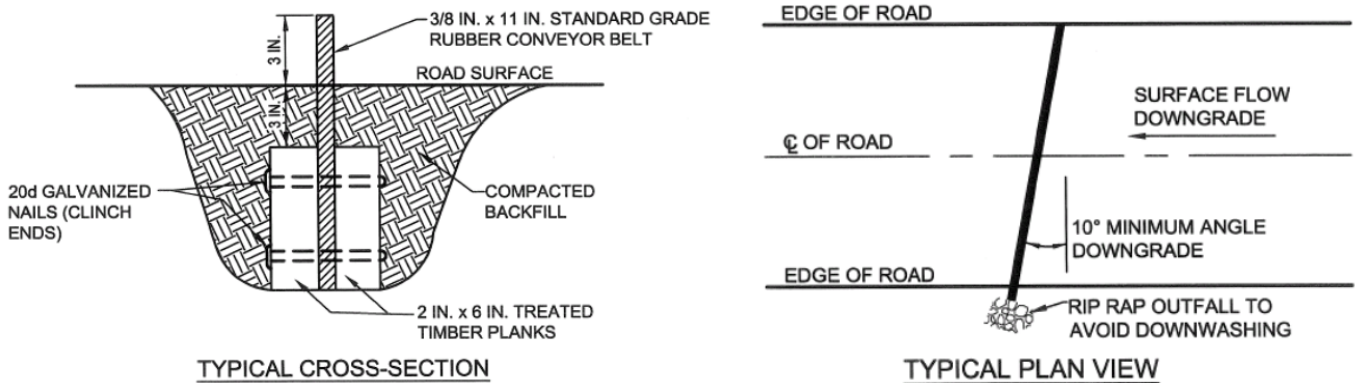

E. Broad-based Dips

Design Standards

- Broad-based dips shall be constructed to the dimensions shown and at the locations shown on the sketch map (Section 4).
- Dips shall be oriented so as to discharge to the low side of the roadway.
- Maximum spacing of broad-based dips shall be as shown in Table 5.

Maintenance

- Dips shall be inspected daily. Damaged or non-functioning dips shall be repaired by the end of the workday.

Will this BMP be used? Yes No

Will recommended spacing be used? Yes No

Table 5. Broad-based Dip Spacing

Road Grade (% Slope)	Recommended Spacing (ft)	Alternative Spacing (ft)*
< 2	300	_____
3	250	_____
4	200	_____
5	180	_____
6	170	_____
7	160	_____
8	150	_____
9	145	_____
10	140	_____

* If alternative spacings are used, please make sure reasons for their use are explained.

Figure 5. Standard Construction Detail for Broad-based Dips

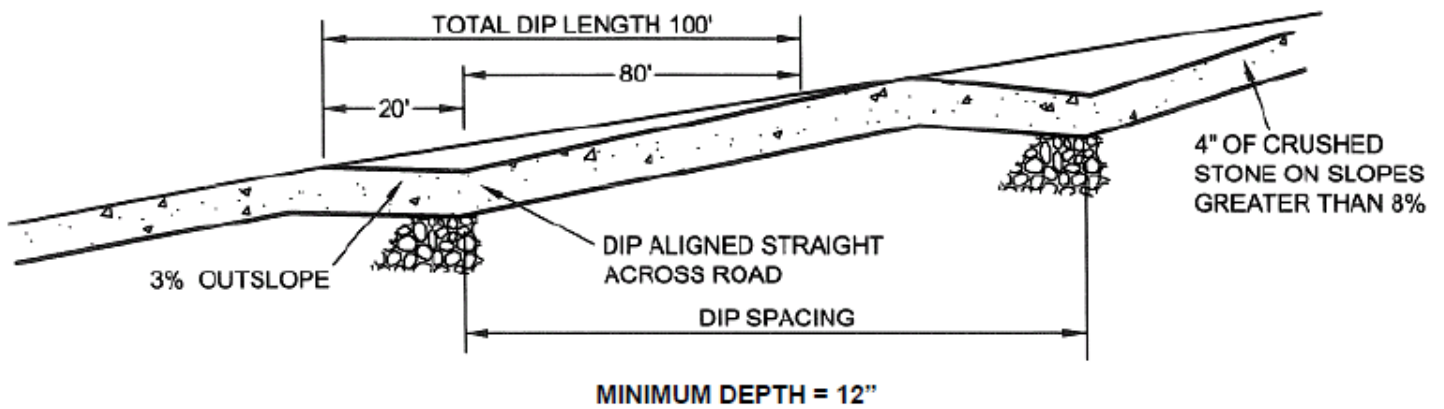

F. Filter Strip

Design Standards

- A filter strip is a strip or area of vegetation used for removing sediment, organic matter, and other pollutants from runoff and wastewater.
- To be effective, runoff should be in the form of sheet flow and the vegetative cover should be established prior to the earth disturbance activity.
- The suitability of natural filter strips should be document by photo(s) as part of the plan.
- Meadow vegetation should be an existing, well-established, perennial grass.
- Forest filter strips consist of vegetation that is predominantly native trees, shrubs and forbs along surface waters that is maintained in a natural state or sustainably managed to protect and enhance water quality, stabilize stream channels and banks, and separate land use activities from surface waters. Trees can be harvested from forest filter strips, but should be winched or otherwise removed in a way that avoids soil disturbance within these areas. Log landings, haul roads and skid trails should be located outside of the filter strip except where stream crossing is necessary.

Maintenance

- If at any time, the width of the filter strip has been reduced by sediment deposition to half its original width, suitable replacement BMPs should be installed. The plan should specify what BMPs will be installed should this occur.

Will this BMP be used? Yes No

Will recommended spacing be used? Yes No

Table 6. Filter Strip Widths

Land Slope of Strip (%)	Recommended Width (ft) Meadow	Alternative Widths (ft)* Meadow	Recommended Width (ft) Forest**	Alternative Widths (ft)* Forest
≤ 10	50	_____	75	_____
20	65	_____	100	_____
30	85	_____	125	_____
40	105	_____	160	_____
50	125	_____	190	_____
60	145	_____	220	_____
70	165	_____	250	_____

* If alternative widths are used, please make sure reasons for their use are explained.

** Consideration should be given to placing a sediment barrier (e.g., wood chip berm, silt fence, straw bales, etc.) immediately below the disturbed area due to minimal sediment removal on typical forest floors.

Figure 6. Standard Construction Detail for Filter Strips

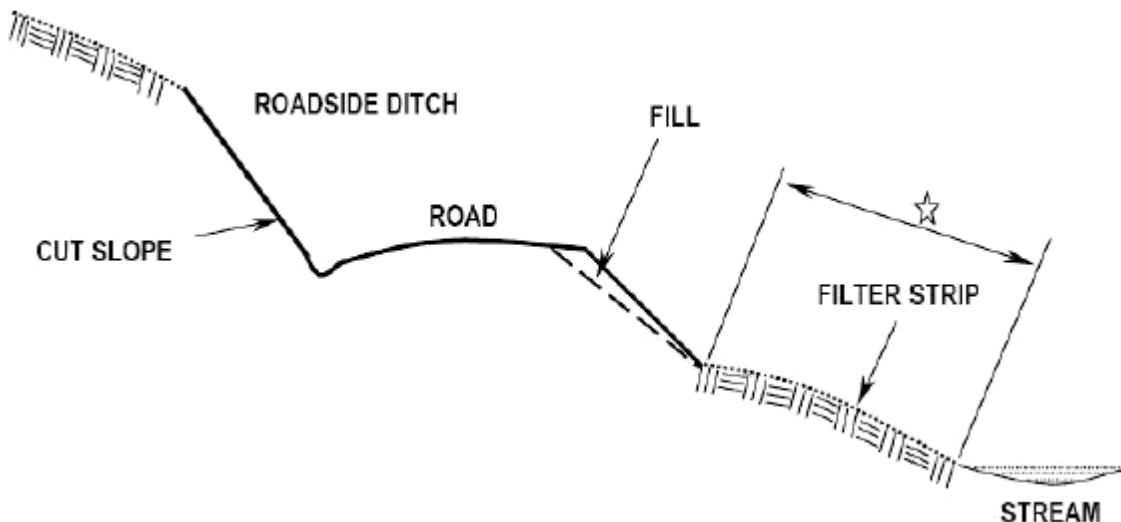

G. Silt Fence (Filter Fabric Fence)

Design Standards

- Fabric shall have the minimum properties as shown in Table 4.3 of the Department’s *Erosion and Sediment Pollution Control Program Manual*.
- The maximum slope length above any silt fence shall not exceed that shown in Table 4.4 of the Department’s *Erosion and Sediment Pollution Control Program Manual*.
- Fabric width shall be 30” minimum. Stakes shall be hardwood or equivalent steel (U or T) stakes.
- Silt fence shall be placed at level existing grade. Both ends of the fence shall be extended at least 8 feet up slope at 45 degrees to the main fence alignment (see Figure 7).
- Fences should not be installed in streams, ditches or other areas of concentrated flow.

Maintenance

- Sediment shall be removed when accumulations reach half the aboveground height of the fence.
- Any section of silt fence which has been undermined or topped shall be immediately replaced with a rock filter outlet.
- Fence shall be removed and properly disposed of when tributary area is permanently stabilized.

Will this BMP be used? Yes No

Will recommended spacing be used? Yes No

Figure 7. Standard Construction Detail for Silt Fence

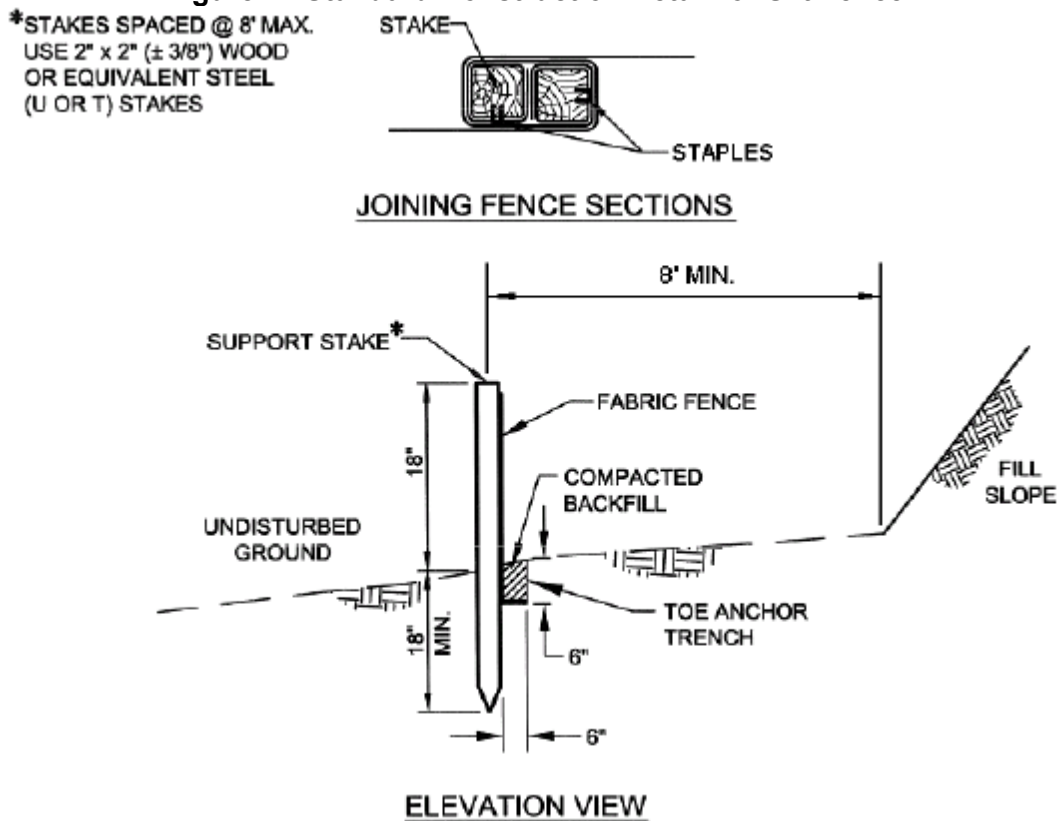

H. Compost Filter Sock

Design Standards

- Sock fabric shall meet standards of Table 4.1, and compost shall meet the standards of Table 4.2 in the Department's *Erosion and Sediment Pollution Control Program Manual*.
- Compost filter sock shall be placed at existing level grade. Both ends of the sock shall be extended at least 8 feet up slope at 45 degrees to the main sock alignment (Figure 8). Maximum slope length above any sock shall not exceed that shown on Figure 4.2 in the Department's *Erosion and Sediment Pollution Control Program Manual*. Stakes may be installed immediately downslope of the sock if so specified by the manufacturer.

Maintenance

- Traffic shall not be permitted to cross filter socks.
- Accumulated sediment shall be removed when it reaches half the aboveground height of the sock and disposed in the manner described elsewhere in the plan.
- Socks shall be inspected weekly and after each runoff event. Damaged socks shall be repaired according to manufacturer's specifications or replaced within 24 hours of inspection.
- Biodegradable filter socks shall be replaced after 6 months; photodegradable socks after 1 year. Polypropylene socks shall be replaced according to manufacturer's recommendations.
- Upon stabilization of the area tributary to the sock, stakes shall be removed. The sock may be left in place and vegetated or removed. In the latter case, the mesh shall be cut open and the mulch spread as a soil supplement.

Will this BMP be used? Yes No

Will recommended spacing be used? Yes No

Figure 8. Standard Construction Detail for Compost Filter Sock

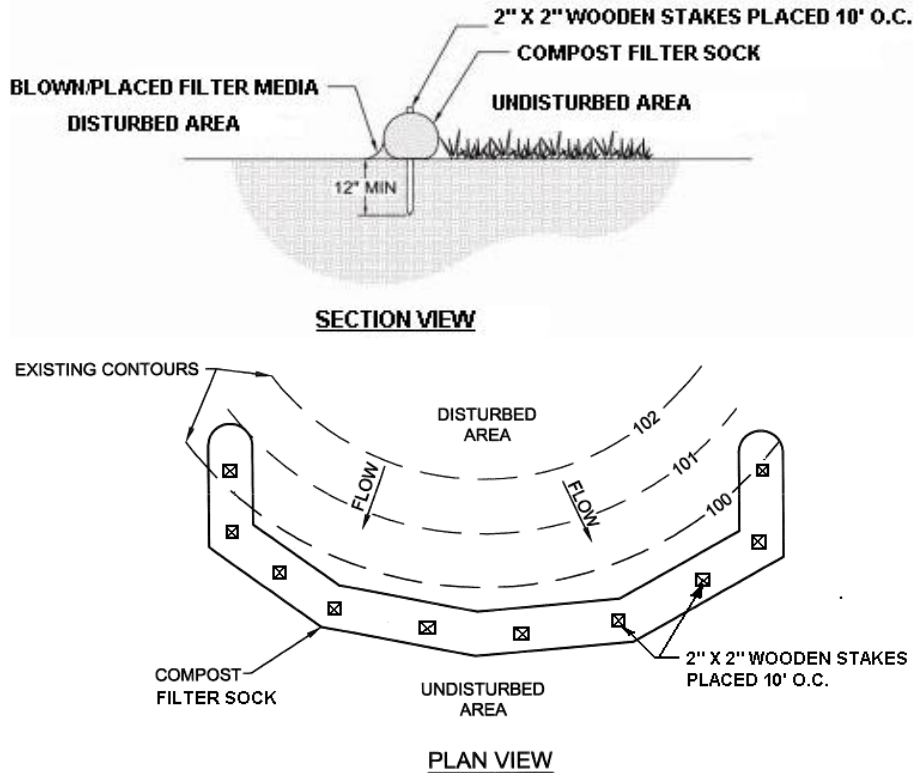

I. Straw Bale Barrier

Design Standard

- The maximum slope length above any straw bale barrier shall not exceed that shown in Table 4.5 of the Department's *Erosion and Sediment Pollution Control Program Manual*.
- Straw bale barriers shall not be used for projects extending more than 3 months.
- Straw bale barriers shall be placed at existing level grade with ends tightly abutting the adjacent bales. First stake of each bale shall be angled toward adjacent bale to draw bales together. Stakes shall be driven flush with the top of the bale (see Figure 4.4 in the Department's *Erosion and Sediment Pollution Control Program Manual*). Both ends of the barrier shall be extended at least 8 feet up slope at 45 degrees to the main barrier alignment (see Figure 4.1 in the Department's *Erosion and Sediment Pollution Control Program Manual*).
- Compacted backfill shall extend approximately 4 inches above ground level.

Maintenance

- Sediment shall be removed when accumulations reach 1/3 the aboveground height of the barrier. Damaged or deteriorated bales shall be replaced immediately upon inspection.
- Any section of straw bale barrier which has been undermined or topped shall be immediately replaced with a rock filter outlet.
- Bales shall be removed when the tributary area has been permanently stabilized.
- They should not be installed in streams, ditches or other areas of concentrated flow.

Will this BMP be used? Yes No

Will recommended spacing be used? Yes No

Figure 9. Standard Construction Detail for Straw Bale Barriers

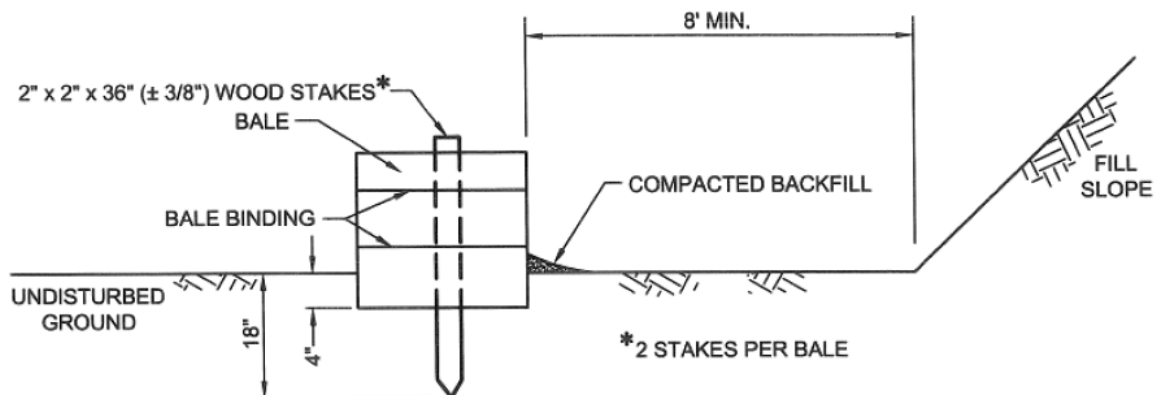

J. Wood Chip Filter Berm

Design Standards

- The maximum slope length above any wood chip filter berm shall not exceed that shown in Table 4.5 of the Department’s *Erosion and Sediment Pollution Control Program Manual*.
- Prior to placement of the berm, obstructions such as tree limbs, large rocks, etc. shall be removed.
- Wood chip filter berm shall be placed at existing level grade. Both ends of the berm shall be extended at least 8 feet up slope at 45 degrees to the main berm alignment (Figure 4.1 in the Department’s *Erosion and Sediment Pollution Control Program Manual*). Wood chip berms shall not be located in areas of concentrated flow or used to construct sediment traps or other impoundments.

Maintenance

- Berms shall be inspected weekly and after each runoff event. Sediment shall be removed when accumulations reach half the height of the berm. Damaged or deteriorated portions of the berm shall be replaced immediately upon inspection.
- Berms may be leveled when the tributary area has been permanently stabilized or left in place.

Will this BMP be used? Yes No

Will recommended spacing be used? Yes No

Figure 10. Standard Construction Detail for Wood Chip Filter Berm

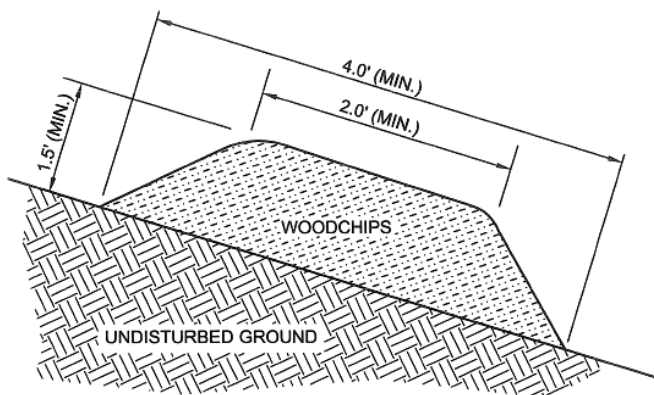

K. Rock Construction Entrance

Design Standards

- A rock construction entrance should be installed wherever it is anticipated that construction traffic will exit the project site onto any roadway, public or private.

- A geotextile underlayment could be placed over the existing ground prior to placing the stone to prevent stone from being driven into the ground.
- Remove topsoil prior to installation of rock construction entrance. Extend rock over full width of entrance.
- Runoff shall be diverted from roadway to a suitable sediment removal BMP prior to entering rock construction entrance.
- Mountable berm shall be installed wherever optional culvert pipe is used and proper pipe cover as specified by manufacturer is not otherwise provided. Pipe shall be sized appropriately for size of ditch being crossed.

Maintenance

- Rock construction entrance thickness shall be constantly maintained to the specified dimensions by adding rock. A stockpile shall be maintained on site for this purpose. All sediment deposited on paved roadways shall be removed and returned to the construction site immediately. If excessive amounts of sediment are being deposited on roadway, extend length of rock construction entrance by 50 foot increments until condition is alleviated or install wash rack. Washing the roadway or sweeping the deposits into roadway ditches, sewers, culverts, or other drainage courses is not acceptable.

Will this BMP be used? Yes No

Figure 11. Standard Construction Detail for Rock Construction Entrance

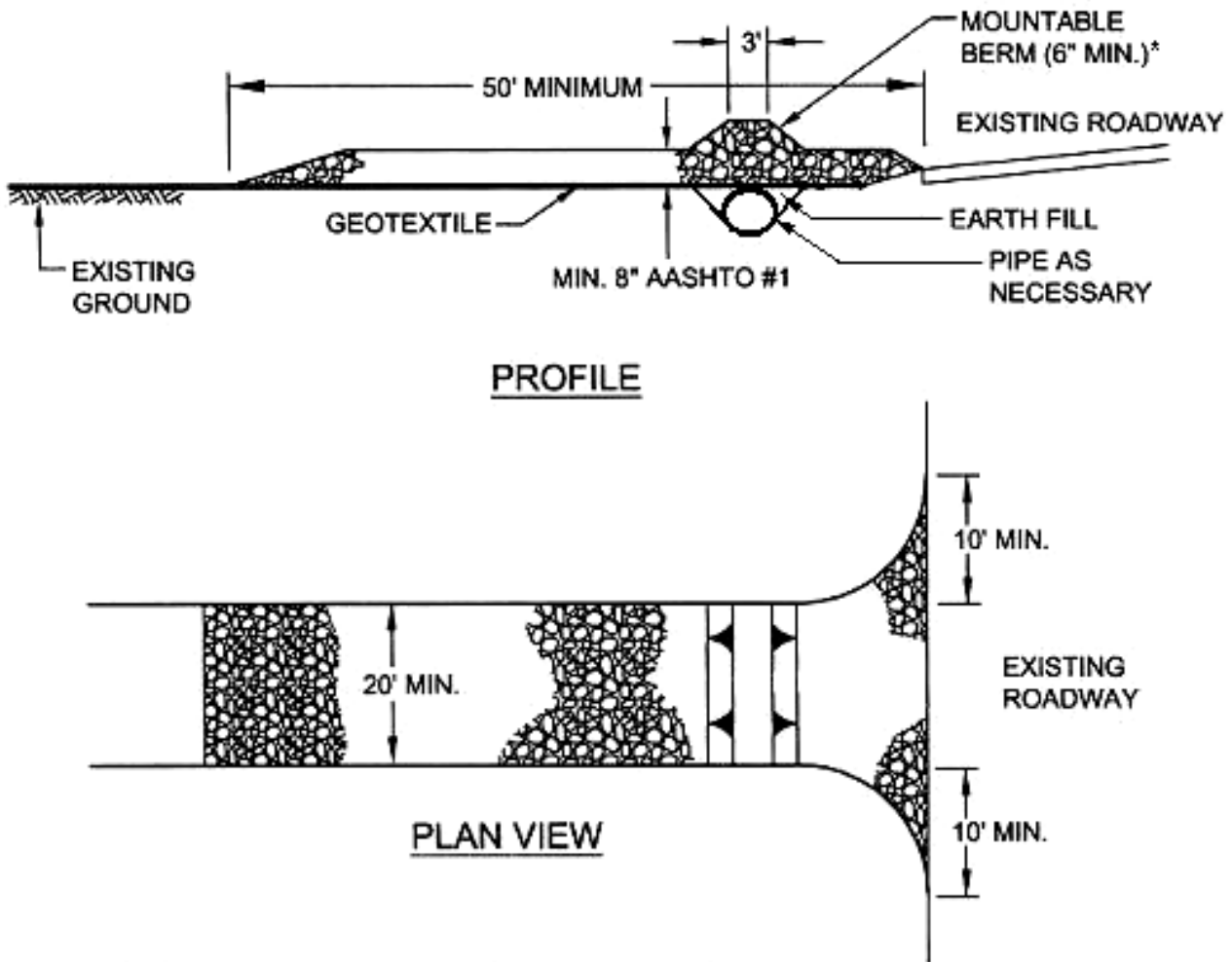

* MOUNTABLE BERM USED TO PROVIDE PROPER COVER FOR PIPE

L. Disturbed Area Stabilization (check as appropriate)

	Seeding ^{1,2}	Natural Vegetation ²
Haul Roads ³	<input checked="" type="checkbox"/>	<input checked="" type="checkbox"/>
Skid Roads ³	<input type="checkbox"/>	<input type="checkbox"/>
Landings ³	<input type="checkbox"/>	<input type="checkbox"/>

¹ Areas to be seeded may require fertilization and liming. Soil testing will provide individualized recommendations for given sites. Recommendations of 500 lbs. of 10-10-10 fertilizer per acre and 2,000 lbs. of lime per acre should be considered to ensure 70% vegetative cover.

² Stabilization of disturbed areas is important. Disturbed areas shall be protected with such BMPs as straw bale barriers, filter fences, mulch, or filter strips, waterbars and other BMPs until vegetation is established. Critical areas such as: highly erodible soils, approaches to stream crossings and landings require establishment of permanent or temporary cover to ensure that erosion does not occur.

³ Indicates treatment for individual landings, haul roads or sections, and skid roads identified on the map.

Seed mix and seeding rate to be used on critical areas. Critical areas are defined as that part of the disturbed area which poses the greatest threat of sediment pollution to a receiving water; such as within floodways, within 50 ft of a wetland, slopes 3H:1V or steeper and erodible soils.(refer to Tables 7 & 8):

Table 7. Recommended Seed Mixtures ¹

Mixture Number	Species	Seeding Rate - Pure Live Seed ²	
		Most Sites	Adverse Sites
1 ³	Creeping red fescue, or	20	25
	Kentucky bluegrass, plus	20	25
	Redtop ⁴ , or	3	5
	Perennial ryegrass	15	20
2	Birdsfoot trefoil, plus	6	10
	Tall fescue	20	25
3	Orchardgrass, plus	15	20
	Perennial ryegrass, plus	15	20
	Birdsfoot trefoil	6	10
4 ⁵	Switchgrass, or	10	15
	Indiangrass, plus	10	15
	Partridge pea	5	10
5 ⁶	Birdsfoot trefoil, plus	6	10
	Timothy, or	20	25
	Perennial ryegrass	20	25

Penn State, "Erosion Control and Conservation Plantings on Noncropland"

¹ Seed and mulch disturbed areas with recommended seed mixtures appropriate for site conditions and further identified in Tables 11.3, 11.4 and 11.5 of the Department's Erosion and Sediment Pollution Control Program Manual

² PLS is the product of the percentage of pure seed times percentage germination divided by 100. For example, to secure the actual planting rate for switchgrass, divide 12 pounds PLS shown on the seed tag. Thus, if the PLS content of a given seed lot is 35%, divide 12 PLS by 0.35 to obtain 34.3 pounds of seed required to plant one acre. All mixtures in this table are shown in terms of PLS.

³ This mixture is suitable for frequent mowing. Do not cut shorter than 4 inches.

⁴ Keep seeding rate to that recommended in table. These species have many seeds per pound and are very competitive. To seed small quantities of small seeds mix with equal parts sand or cat litter to ensure even spreading.

⁵ This mix contains only species that are native to Pennsylvania.

⁶ Do not mow shorter than 9 to 10 inches.

Table 8. Recommended Seed Mixtures for Stabilizing Disturbed Areas

Site Condition	Nurse Crop ¹	Seed Mixture (Select one mixture)
Slopes and Banks (not mowed) Well-drained Variable drainage	1 plus 1 plus	1, 2, 3, 4 or 5 1, 3 or 5
Slopes and Banks (mowed) Well-drained	1 plus	1 or 2
Slopes and Banks (grazed/hay) Well-drained	1 plus	3, 4 or 5
Gullies and Eroded Areas	1 plus	1 or 2
Erosion Control Facilities (BMPs)		
• Sod waterways, spillways, frequent water flow areas	1 plus	1 or 2
• Drainage ditches	1 plus	1, 2 or 5
• Shallow, less than 3 feet deep	1 plus	1 or 2
• Deep, not mowed	1 plus	1 or 2
• Pond banks, dikes, levees, dams, diversion channels, and occasional water flow areas	1 plus	1, 2 or 3
• Mowed areas	1 plus	4 or 5
• Non-mowed areas	1 plus	4 or 5
• For hay or silage on diversion channels and occasional water flow areas	1 plus	2 or 9

Penn State, "Erosion Control and Conservation Plantings on Noncropland"

¹ Nurse Crops should be added to all mixes to improve soil stabilization and increase the chance of establishment. Nurse crops can be mixed in with the desired seed mix. When using in combination with another mix, they should be applied at a rate of 1 bushel (~30lbs) per acre. If used alone on a site, they should be applied at 2 bushels (~60lbs) per acre. Use Spring oats (*Avena fatua*) if seeding prior to August 15th and use Winter rye (*Secale cereale*) if seeding after August 15th. Annual rye (*Lolium multiflorum*) may be used instead of oats or winter rye if desired.

9. NATURAL GEOLOGIC FORMATIONS OR SOIL CONDITIONS THAT HAVE THE POTENTIAL TO CAUSE POLLUTION

This section addresses soils or geologic formations containing minerals in sufficient quantities that could result in discharges which do not meet water quality standards. All locations of known such instances should be noted on the plan, and appropriate measures taken to minimize impacts to those locations. This can include, but is not limited to, pyritic materials and slide-prone soils.

Will the timber harvest impact soils and geologic formations that could result in a pollution event?
 Yes No

If the answer is yes, additional information must be included in the plan to address these features. This could include contingency plans, disposal plans, and treatment plans, dependent on the type of impact.

10. THERMAL IMPACTS TO SURFACE WATERS

This section addresses maintaining ambient temperature of Waters of the Commonwealth from impacts, primarily those associated with the removal of vegetation through timber harvesting activities which could cause detrimental impacts to aquatic resources. The best site practice/BMP to address thermal pollution is the maintenance or creation of a filter strip (Section 8.F) on surface waters and maintenance of vegetation in wetlands.

Will the timber harvest create thermal impacts to Waters of the Commonwealth, including cold water fisheries, wilderness trout streams, and exceptional value wetlands? Yes No

If the answer is yes, additional information must be included in the plan to address these features. This could include treatment and/or mitigation plans, dependent on the type of impact.

11. SCHEDULE AND SEQUENCE OF OPERATIONS

Starting Date _____ Completion Date _____

Pre-harvest: Necessary permits will be obtained. Erosion and sediment control BMPs will be installed as specified in this plan. Haul road, landings and skid roads will be constructed.

During harvest: Erosion and sediment control BMPs for haul roads, skid roads and landings shall be maintained. Tops, branches and slash will be removed from ponds, lakes and streams. This plan will be amended or revised to include other BMPs for special or unanticipated circumstances that may occur.

Post-harvest: Smooth and reshape roads and landings. Remove culverts and crossings. Install permanent waterbars as specified in this plan. Critical areas will be seeded, fertilized, limed and mulched and garbage/trash removed from the area.

If this schedule and sequence of operations will not be used, please provide additional information in Section 14.

12. MAINTENANCE

- BMPs will be inspected on a weekly basis and after each stormwater event.
- Written documentation of these inspections and any maintenance/repairs/replacements will be recorded.
- Follow the maintenance criteria for each BMP listed in Section 8.
- Protection should be maintained around seeps soaks and springs near earth disturbance areas.
- Haul roads and skid roads will be repaired where signs of accelerated erosion are detected.
- Seeding and mulching will be repeated in those areas that appear to be failing or have failed.
- Material removed from BMPs should be placed outside any floodways, wetlands, or Waters of the Commonwealth.

Other (describe)

Other party assigned to be responsible for construction and maintenance of the E&S BMPs

_____		_____	
Name		Home Phone	Work Phone

Street Address			
_____		_____	
City	State	Zip Code	Signature of person(s) responsible

13. SITE CLEANUP

Describe procedures which ensure the proper handling, storage, control, disposal and recycling of timber harvesting materials and waste, including but not limited to fuels, oil, lubricants and other materials brought to the timber harvest site or used in the process of timber harvesting.

- Garbage, fuels or any substance harmful to human, aquatic or fish life, will be prevented from entering springs, streams, ponds, lakes, wetlands or any water course or water body.
- Oils, fuels, lubricants and coolants will be placed in suitable containers and disposed properly.
- All trash and garbage will be collected and disposed properly.
- Preparedness, Prevention and Contingency (PPC) Plan prepared for the site.
- Other (describe):

Emergency Contact Numbers:

DEP:

PA Fish & Boat Commission:

Municipality:

Other:

14. ADDITIONAL EXPLANATION/COMMENTS (if needed)

Schedule and Sequence of Operations as specified in the Collins Road contract specifications.

SGL #138
ADMIN ROAD MAINTENANCE

PROJECT NO: PGC_SW11_FY23

SCOPE OF WORK – SEQUENCE OF CONSTRUCTION

Refer to the Technical Specifications for material requirements and construction / installation procedures for the different items of work.

A. ROAD SECTION (6,145')

- A.1 Provide Soil Erosion and Sedimentation Control BMPs as required and specified and as directed by PGC staff. Maintain, modify, and add controls as required during construction to address and prevent erosion issues. The Contractor shall contact the Pennsylvania One Call System, Inc. by phone at 1-800-242-1776 or their website (www.pa1call.org) to notify affected utilities and to coordinate utility locations prior to earthwork and excavation operations at the site.

- A.2 Clear and grub trees, stumps, and vegetation along 6,145 linear feet to widen the existing road corridor, minimum of 60-feet wide (30-feet from road centerline), for road construction operations. Other trees that interfere with construction operations may also be cut and stumps removed. Cleared trees shall be placed outside the limits of construction adjacent to but not in the proposed road surface, ditches, or drainage channels. All disturbed areas outside the road corridor shall be graded and blended into the ditch line. All merchantable saw logs must be removed as directed by PGC staff.
 - A.2.1 Trees along the SGL Boundary Line may not be felled or pushed across the boundary. The PGC Boundary (white paint) must remain intact and shall be cleared of all debris.
 - A.2.2 The Whitetail Trail crosses the SGL 138 Admin Road (as shown on the map). The trail must remain intact and shall be cleared of all debris.
 - A.2.3 All trees and debris shall be placed to the east side of the SGL 138 Admin Road where possible and scattered out to reduce piling. Trees (minus the merchantable saw logs) and debris near the SGL Boundary or any other areas that must be placed to the west of the Admin Road shall be reduced in size by a forestry mulching head or chipped to facilitate prescribed fire operations.
 - A.2.4 Machines with habitat heads may be used for land clearing activities.

- A.3 Grade and shape road to a minimum 25-foot corridor width and 18-foot wide ditch line to ditch line with a minimum 16-foot cartway width not exceeding a 10% grade. Reestablish centerline crown shape with 6% cross slopes as specified and as shown on the drawings / details.

- A.3.1 Existing earth berms along the road edges shall be graded to open the road corridor and allow positive drainage away from the crowned road surface. Berm material shall be evenly spread adjacent to the roadway if site conditions permit or shall be excavated, removed, and hauled to an on-site spoil area as directed by PGC staff.
- A.3.2 Soft base material shall be excavated or graded out of the existing road surface. Base material shall be evenly spread adjacent to the roadway if site conditions permit or shall be excavated, removed, and hauled to an on-site spoil area as directed by PGC staff.
- A.3.3 Cleanout and grade ditch lines that direct surface water runoff flow to turnouts or culverts. Reestablish and extend turnouts and culvert tail ditches to direct runoff away from the road and to allow free gravity flow (daylight) to eliminate ponding
- A.3.4 Provide new turnouts and broad-based dips as required and as directed by PGC staff to provide positive drainage and to control and direct stormwater runoff away from roadway and to daylight.
- A.3.5 Grade and widen the entrance apron to Skyline Drive to allow trucks with trailers easy ingress/egress onto the Admin Road.
- A.3.6 Compact graded and shaped roadway with a 10-Ton (minimum) single smooth drum vibratory roller.
- A.4 Provide and install eleven (11) 15” diameter x 25-foot shallow drain pipes.
One existing drainpipe will be replaced and must be removed from the game lands by the contractor.
- A.4.1 Provide PennDOT 2A Coarse Aggregate pipe bedding compacted in 6-inch lifts with a stand-up hand operated or walk behind vibratory compactor to 12” above top of pipe.
- A.4.2 R-4 Limestone riprap discharge aprons shall be provided and placed in the tail ditch at culvert pipe outlets. The riprap apron shall be 4-feet wide by 10-feet long by 1-foot thick.
- A.4.3 Coordination with the PGC Regional Forester or his designee to ensure a PGC representative is on site to observe installation of all drain pipes.
- A.5 Provide and install twenty-two (22) headwalls (inlet and outlet) w/ bank walls (if required) on the newly installed shallow drain pipes. Coordinate with the PGC

Regional Forester or his designee to ensure a PGC representative is on site to observe installation of all headwalls.

A.6 Provide and install one (1) French Mattresses at locations delineated by a PGC representative.

A.6.1 Excavate the mattress to a minimum width of 18 feet across the road surface ditch to ditch and to a desired depth of 3 feet and slope at a distance as designated in A.7 allowing for min 12 inches of compacted 2A stone cover over the mattress.

A.6.2 Provide Class 1 Non-woven Geotextile fabric to overlap and wrap the stone to create the mattress as specified in the drawing and details.

A.6.3 Provide and place AASHTO #1 Coarse Aggregate on top of the fabric and spread into a uniform bed of the desired depth.

A.6.4 Shape and compact fill overtop the finished mattress. Establish the desired road surface shape.

A.6.5 Coordination with the PGC Regional Forester or his designee to ensure a PGC representative is on site to observe installation of the French Mattress.

A.7 Provide and install non-woven geotextile fabric (minimum of 11 oz material) along 300 linear feet by 15 feet wide over road subbase, where needed, prior to base stone application as delineated on the map.

A.8 Resurface entire length (6,145') of the roadway with coarse aggregate as follows:

A.8.1 Provide AASHTO#1 Limestone Coarse Aggregate road subbase minimum of 17-foot wide x 6-inches compacted depth where drainage and subbase stabilization is necessary (spot treatment). Maintain centerline crown shape with 6% cross slopes. Material should be feathered out to the ditch line to avoid creating a berm. Compact with a 10-Ton (minimum) single smooth drum vibratory roller.

A.8.2 Provide PennDOT 3A Limestone Modified Coarse Aggregate road base minimum of 17-foot wide x 6-inches compacted depth. Maintain centerline crown shape with 6% cross slopes. Material should be feathered out to the ditch line to avoid creating a berm. Compact with a 10-Ton (minimum) single smooth drum vibratory roller.

A.8.3 Provide PennDOT 2A Limestone Modified Coarse Aggregate road surface minimum of 16-foot wide x 4-inches compacted depth. PennDOT 2RC may be substituted on steeper grades to reduce the washboard potential. Use of

2RC will be at the discretion of the Regional Forester. Maintain centerline crown shape with 6% cross slopes. Material should be feathered out to the ditch line to avoid creating a berm. Compact with a 10-Ton (minimum) single smooth drum vibratory roller.

- A.8.3 Create access aprons to transition the newly improved road to any existing roads. Coordinate these access areas in the field with PGC staff.

B. PARKING AREAS

B.1 Provide Soil Erosion and Sedimentation Control BMPs as required and specified and as directed by PGC staff. Maintain, modify, and add controls as required during construction to address and prevent erosion issues.

B.2 Improve and resurface four (4) existing parking areas as shown on the map. All four (4) parking areas shall be 40 feet by 80 feet. Coordinate parking area layout in the field with PGC staff.

B.2.1 Excavate, grub, and grade area to conform to and blend with existing ground contours and to allow water runoff to sheet flow across the site.

B.2.3 Provide 3A Limestone Modified Coarse Aggregate base 6-inch compacted depth. Compact with a 10-Ton (minimum) single smooth drum vibratory roller.

B.2.4 Provide PennDOT 2A Limestone Modified Coarse Aggregate surface 4-inch compacted depth. Compact with a 10-Ton (minimum) single smooth drum vibratory roller.

C. RESTORATION

Immediately grade, restore, reclaim, and stabilize the borrow site and all disturbed areas beyond the limits of the stabilized road surface then seed and mulch.

COMMONWEALTH OF PENNSYLVANIA
PENNSYLVANIA GAME COMMISSION

PROPOSAL FORM WORKSHEET – MAINTENANCE SERVICE

DESCRIPTION: **SGL #138 Admin Road Maintenance**

PROJECT NO.: **PGC_SW11_FY23**

LOCATION OF WORK: State Game Lands #138 in Georges Township, Fayette County

DATE DUE: **February 29, 2024 TIME: 2:00 P.M.**

TO: Pennsylvania Game Commission, Bureau of Administrative Services, Contracts and Procurement Division, 2001 Elmerton Ave., Harrisburg, PA 17110-9797

In response to this proposal, the undersigned hereby proposes to furnish all labor, materials, tools and equipment to perform the work for the above described project, in strict accordance with applicable Commonwealth Regulations, Specifications and Plans for the Price of:

NOTE: THIS FORM IS FOR INFORMATIONAL PURPOSES ONLY AND IS ONLY INTENDED FOR VENDOR’S USE AS A WORKSHEET. ALL BIDS SHALL BE SUBMITTED ELECTRONICALLY IN ACCORDANCE WITH THE BID NOTICE AND BID DOCUMENTS.

<u>No.</u>	<u>Work Item</u>	<u>Estimated Quantity</u>	<u>Unit Price</u>	<u>Total Price</u>
1	ADMINISTRATION, MOBILIZATION, TERMS AND CONDITIONS, CONTRACT BONDS – SGL 138 ADMIN ROAD, FAYETTE CO., PA	Job	Lump Sum	\$ _____
2	SOIL EROSION AND SEDIMENTATION CONTROL	Job	Lump Sum	\$ _____
3	CLEARING AND GRUBBING –ALONG ROADWAY	6,145 LF	\$ _____/LF	\$ _____
4	GRADE AND SHAPE ROADWAY	6,145 LF	\$ _____/LF	\$ _____
5	15” DRAIN PIPE	275 LF	\$ _____/LF	\$ _____
6	DRAIN PIPE BEDDING AND BACKFILL – PENNDOT 2A COARSE AGGREGATE (90 TONS/DRAIN PIPE)	1,000 Tons	\$ _____/Ton	\$ _____

7	STONE HEADWALLS	22 Each	\$ _____/Each	\$ _____
8	R-4 LIMESTONE RIP RAP - DISCHARGE APRONS	25 Tons	\$ _____/Ton	\$ _____
9	FRENCH MATTRESS (1)- 25 TONS AASHTO #1 COARSE AGGREGATE & GEOTEXTILE	Job	Lump Sum	\$ _____
10	NON-WOVEN GEOTEXTILE FABRIC	300 LF	\$ _____/LF	\$ _____
11	AASHTO #1 COARSE AGGREGATE SUBBASE AS NEEDED – ROADWAY & NEW PARKING AREA	100 Tons	\$ _____/Ton	\$ _____
12	3A LIMESTONE MODIFIED COARSE AGGREGATE BASE – ROADWAY	3,200 Tons	\$ _____/Ton	\$ _____
13	PENNDOT 2A LIMESTONE COARSE AGGREGATE SURFACE – ROADWAY	2,050 Tons	\$ _____/Ton	\$ _____
14	EXCAVATE, GRADE AND SHAPE EXISTING PARKING AREAS - SECTION “B”	Job	Lump Sum	\$ _____
15	3A LIMESTONE MODIFIED COARSE AGGREGATE - PARKING AREA BASE (125 TONS / PA)– SECTION “B”	500 Tons	\$ _____/Ton	\$ _____
16	PENNDOT 2A LIMESTONE COARSE AGGREGATE PARKING AREA SURFACE (90 TONS / PA)– SECTION “B”	360 Tons	\$ _____/Ton	\$ _____
17	RESTORATION - SECTION “C”	Job	Lump Sum	\$ _____
Total Project Cost	\$ _____			

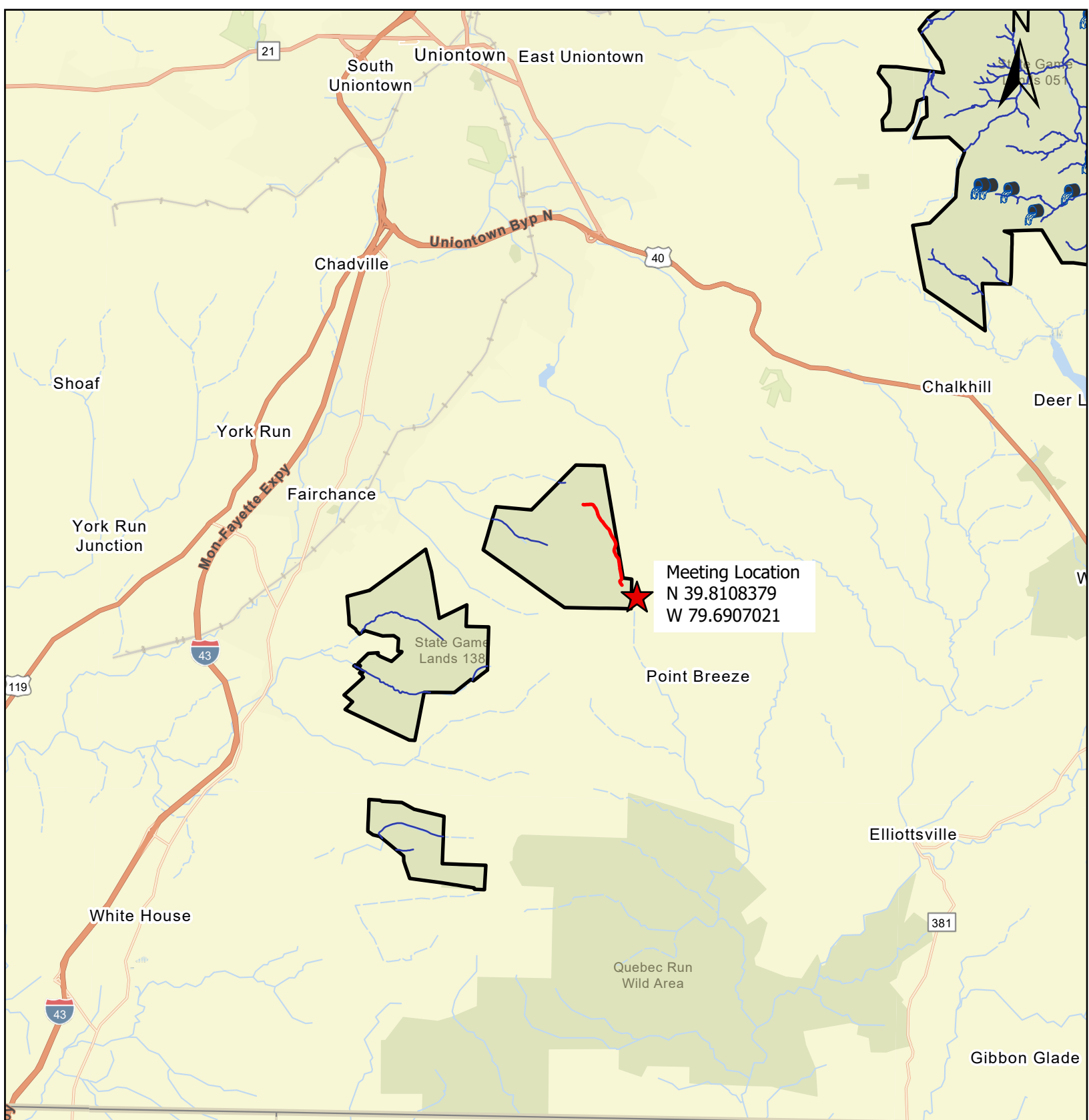

Location Map for Admin Road- 6,145'

Project ID # PGC_SW11_FY23
SGL 138

Fayette County
Georges Township

Legend

- SGL138_AdminRoad
- Stream

data.pa.gov, Esri, TomTom, Garmin, SafeGraph, GeoTechnologies, Inc, METI/NASA, USGS, EPA, NPS, USDA, USFWS





White Rock Hollow

Cave Hollow

Skyline Dr

Kirby Rd

Skyline Dr

Laurel Rd

Skyline Dr

Project Map for Admin Road- 6,145'

Project ID # PGC_SW11_FY23
SGL 138

Fayette County
Georges Township

Meeting Location
N 39.8108379
W 79.6907021

Esri Community Maps Contributors, data,
SafeGraph, GeoTechnologies, Inc, METI/NASA, USGS,



Legend

- SGL138_AdminRoad

CulvertLocations

- Proposed
- Replace
- FrechMattress
- Parking_Area
- Stream

ROW Line

- Gas Line
- Trail

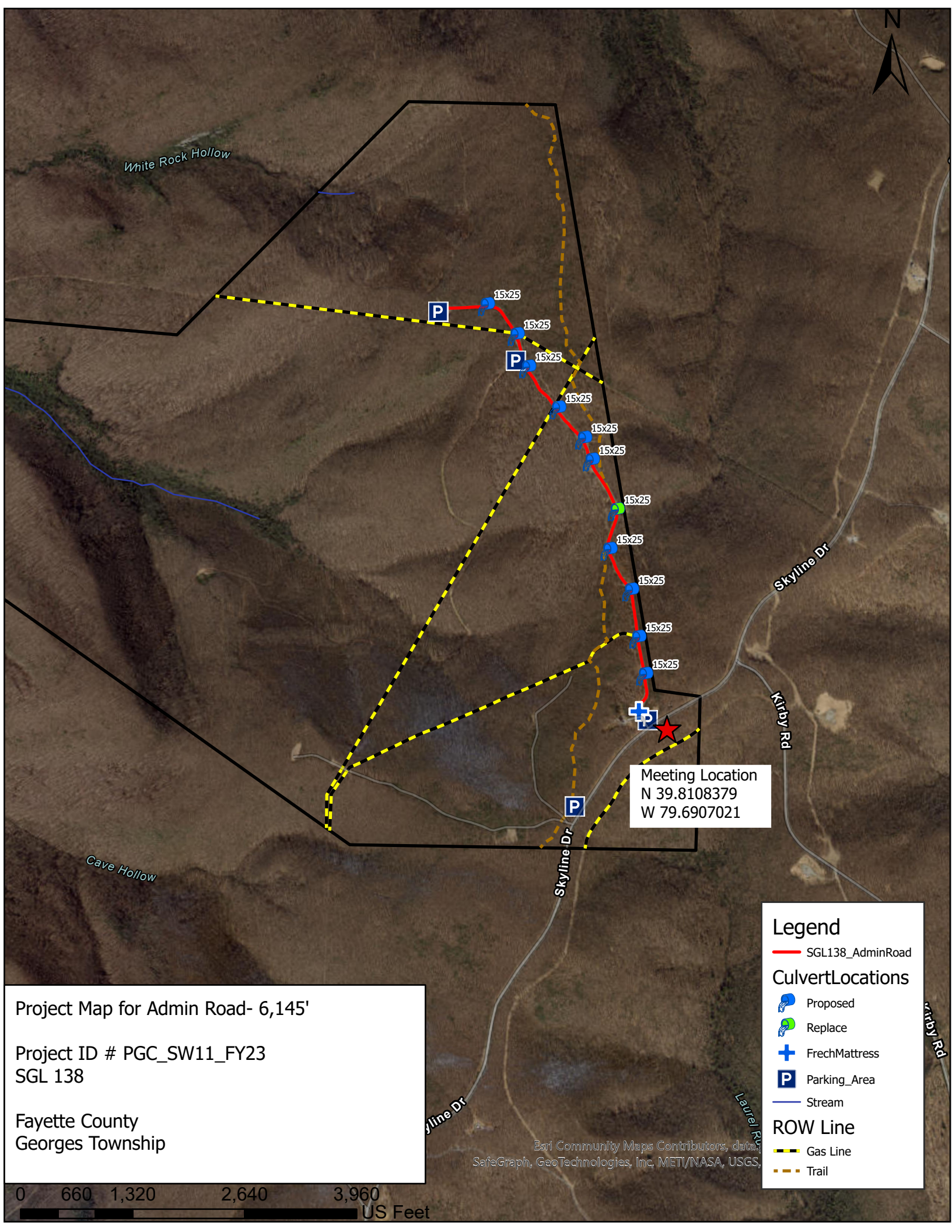

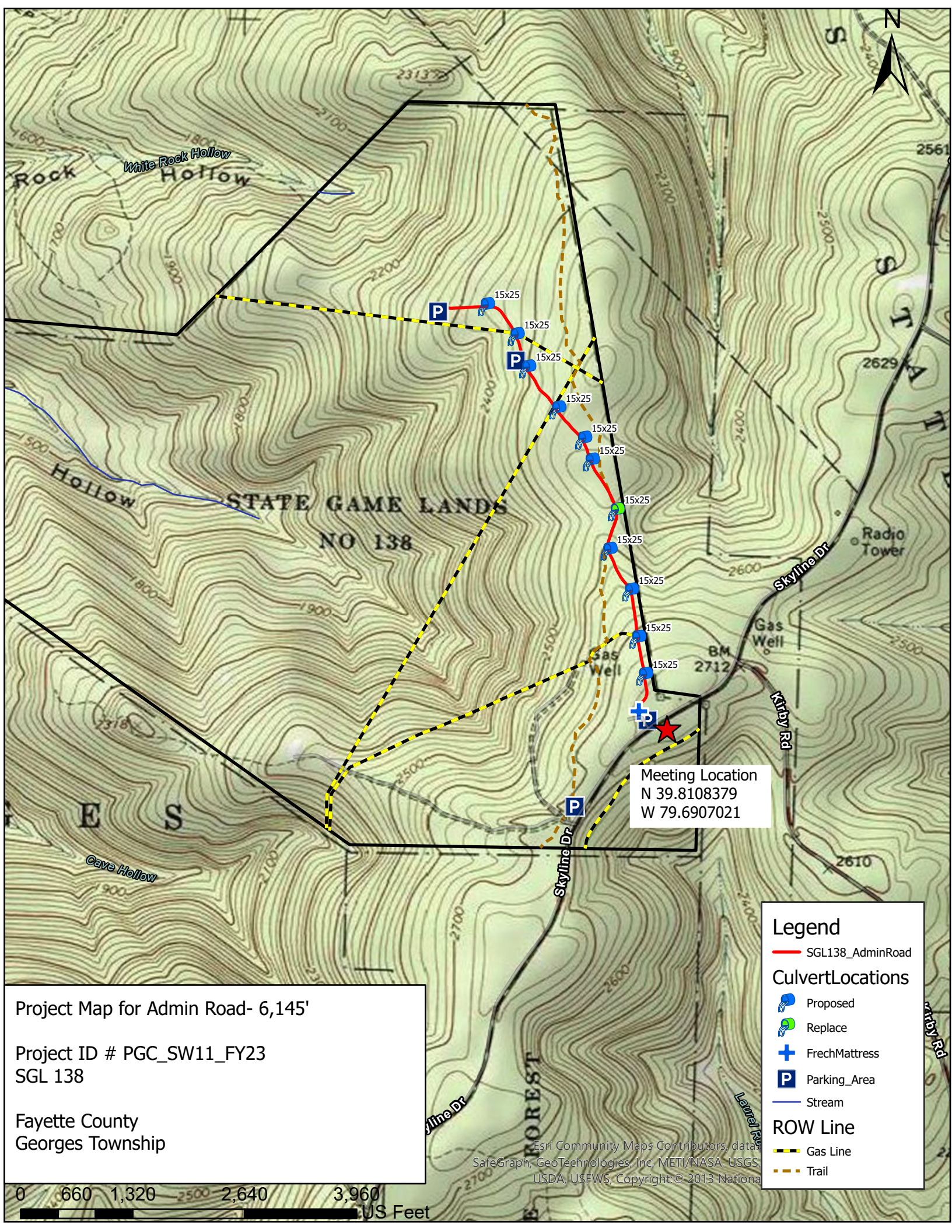

Project Map for Admin Road- 6,145'

Project ID # PGC_SW11_FY23
SGL 138

Fayette County
Georges Township

Meeting Location
N 39.8108379
W 79.6907021

Legend

- SGL138_AdminRoad

CulvertLocations

- Proposed
- Replace
- FrechMattress
- Parking_Area
- Stream

ROW Line

- Gas Line
- Trail

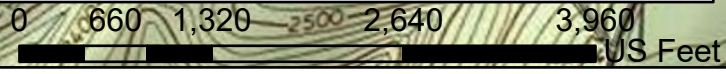

Esri Community Maps Contributors, data, SafeGraph, GeoTechnologies, Inc, METI/NASA, USGS, USDA, USFWS, Copyright © 2013 National

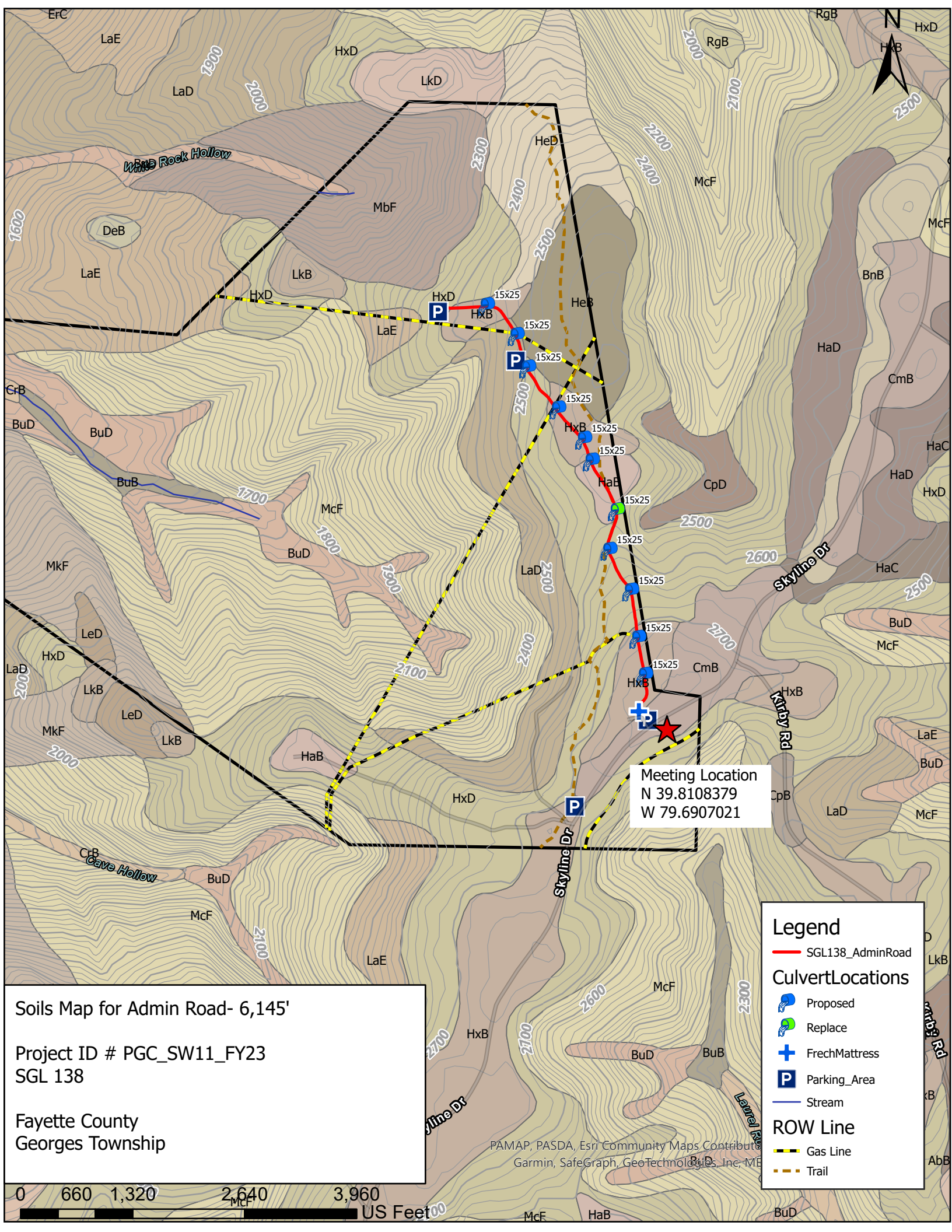

Soils Map for Admin Road- 6,145'

Project ID # PGC_SW11_FY23
SGL 138

Fayette County
Georges Township

Meeting Location
N 39.8108379
W 79.6907021

Legend

- SGL138_AdminRoad

CulvertLocations

- Proposed
- Replace
- FrechMattress
- Parking_Area
- Stream

ROW Line

- Gas Line
- Trail



PAMAP, PASDA, Esri Community Maps Contributor
Garmin, SafeGraph, GeoTechnology, Inc, ME

CONSTRUCTION NOTES:

1. GRADE ROADWAY SUBGRADE TO REQUIRED WIDTH WITH CENTER CROWN AS SHOWN. PROVIDE GRADE BREAKS AND BROAD BASED DIPS AS REQUIRED OR AS DIRECTED BY PGC STAFF TO ACCOMMODATE THE ROAD GRADE, TERRAIN, AND SITE CONDITIONS TO FACILITATE DRAINAGE ALONG AND ACROSS ROADWAY. COMPACT SUBGRADE WITH 10-TON (MIN.) VIBRATORY DRUM ROLLER.
2. PROVIDE 3A MODIFIED COARSE AGGREGATE ROAD BASE - 6" MIN. COMPACTED DEPTH WITH CENTER CROWN AS SHOWN. COMPACT AGGREGATE BASE WITH 10-TON (MIN.) VIBRATORY DRUM ROLLER.
3. REMOVE EXISTING EARTH BERMS AS REQUIRED AND DIRECTED BY PGC STAFF.
4. PROVIDE DITCHES AND DITCH TURNOUTS AS SHOWN OR AS DIRECTED BY PGC STAFF TO COLLECT AND DIRECT STORMWATER RUNOFF AWAY FROM ROAD SURFACE AND TO DAYLIGHT.
5. PROVIDE PENNDOT 2A COARSE AGGREGATE ROAD SURFACE - 4" MINIMUM COMPACTED DEPTH WITH CENTER CROWN AS SHOWN. COMPACT WITH 10-TON (MIN.) VIBRATORY DRUM ROLLER.

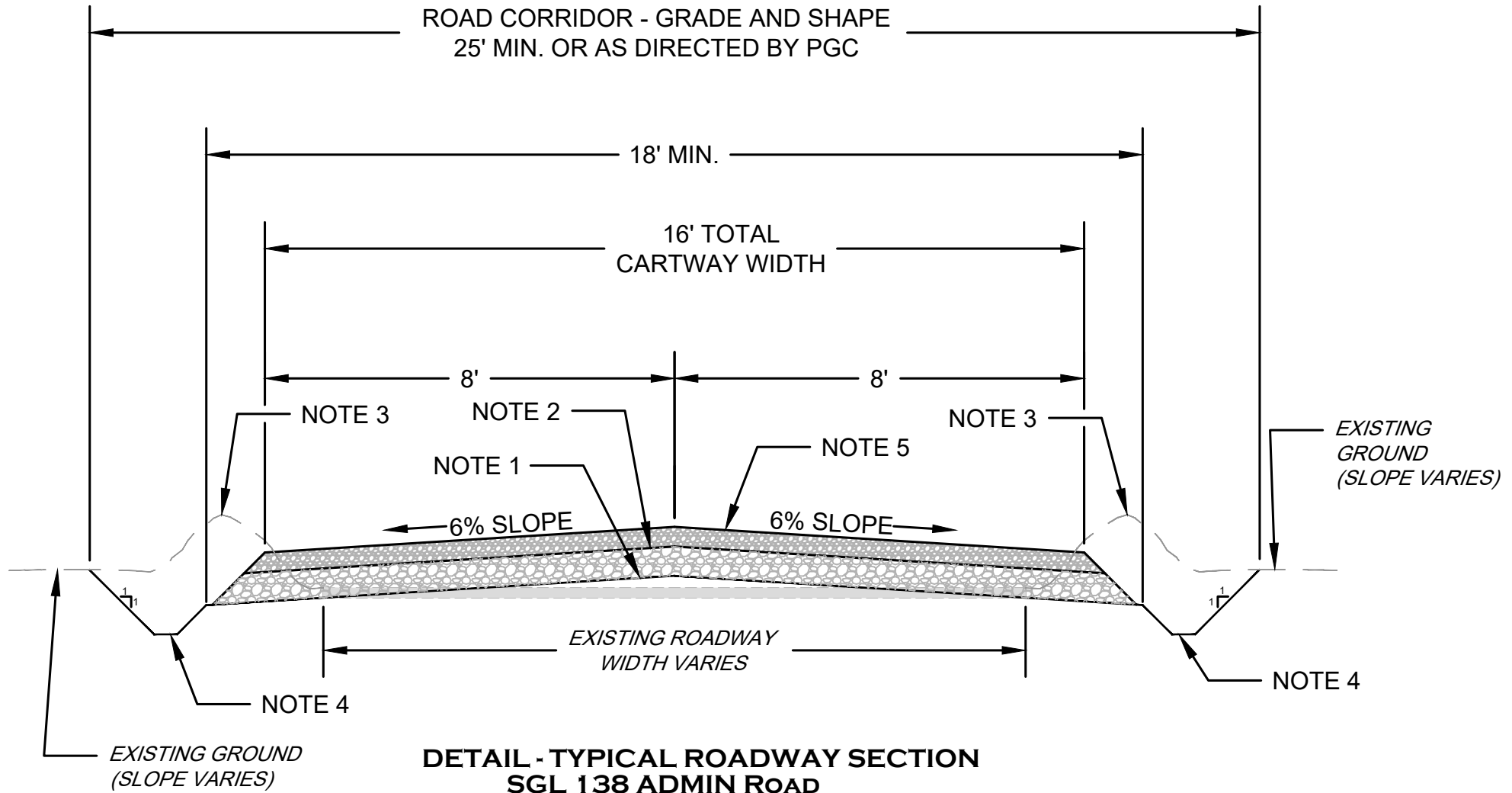

NOT TO SCALE

1. GRADE ROADWAY SUBGRADE TO REQUIRED WIDTH WITH CENTER CROWN AS SHOWN. PROVIDE GRADE BREAKS AND BROAD BASED DIPS AS REQUIRED OR AS DIRECTED BY PGC STAFF TO ACCOMMODATE THE ROAD GRADE, TERRAIN, AND SITE CONDITIONS TO FACILITATE DRAINAGE ALONG AND ACROSS ROADWAY. COMPACT SUBGRADE WITH 10-TON (MIN.) VIBRATORY DRUM ROLLER.
2. REMOVE AND GRADE EXISTING EARTH BERMS ALONG ROAD AS REQUIRED AND DIRECTED BY PGC STAFF.



DETAIL – ROAD SECTION GRADED AND ROLLED PRIOR TO BASE STONE APPLICATION

TYPICAL TURNOUT DETAIL

Channels that drain water away from roads or roadside ditches into well-vegetated areas are known as turnouts. Turnouts (see Figure 3.3) are typically located along crowned roadways where runoff cannot sheet flow off the roadway. Like ditch relief culverts, the purpose of turnouts is to minimize the volume of water in a roadside ditch. Turnouts should be located so as to take advantage of natural drainage courses or buffer areas wherever possible. **An excavated sump at the end of the turnout can be effectively used to pond and settle out sediment prior to discharging to a vegetated buffer.** Where a suitable vegetative filter strip is not available, a compost filter sock, rock filter or other sediment removal BMP should be installed at the outlet of the turnout.



Source Unknown

FIGURE 3.3
Typical Turnout

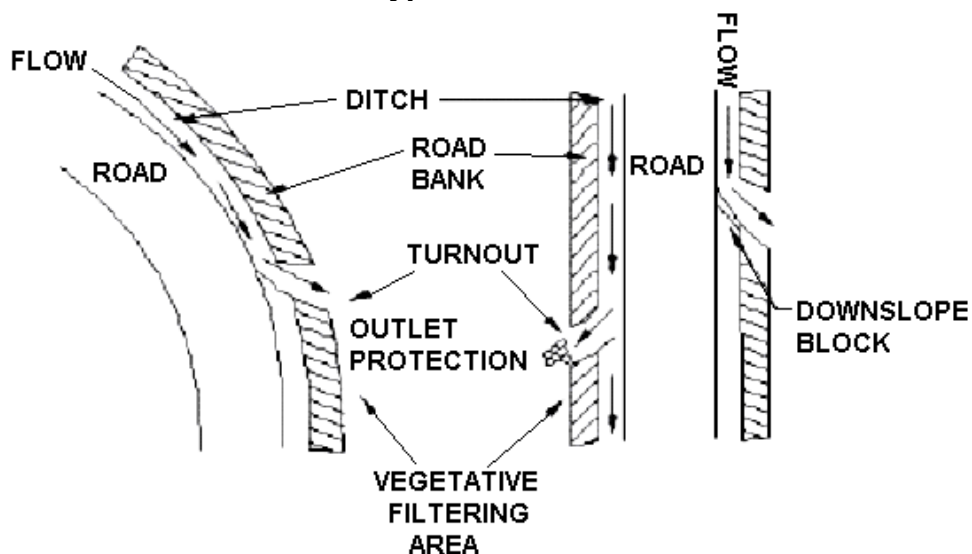

Indiana CCD

Technical Bulletin

Shallow Crosspipes

SHALLOW CROSSPIPE * -- A drainage culvert (road ditch outlet) installed to discharge at natural ground elevation, avoiding the need for an outlet trench or "tail-ditch."

* Please also see the Center's related technical bulletin for crosspipe installation procedures.

The key to a **shallow crosspipe** is to allow the "Natural Ground Elevation" at the pipe outlet to determine the crosspipe elevation. Natural Ground Elevation simply refers to the height of the existing land at the pipe outlet. A traditional crosspipe, illustrated on the left below, uses the road surface elevation to determine the pipe installation depth. This can result in an excessively deep pipe, since the required pipe cover is often achieved by excavating deeper into the road. This method often requires an outlet trench, or "tail-ditch," which is a constant source of maintenance and erosion. By contrast, a **shallow crosspipe** is placed at an elevation where it drains to natural ground. Pipe cover is then obtained by importing fill over the pipe, not by digging deeper into the road. The best way to understand a shallow pipe is to compare it to a traditional deep pipe as shown below.

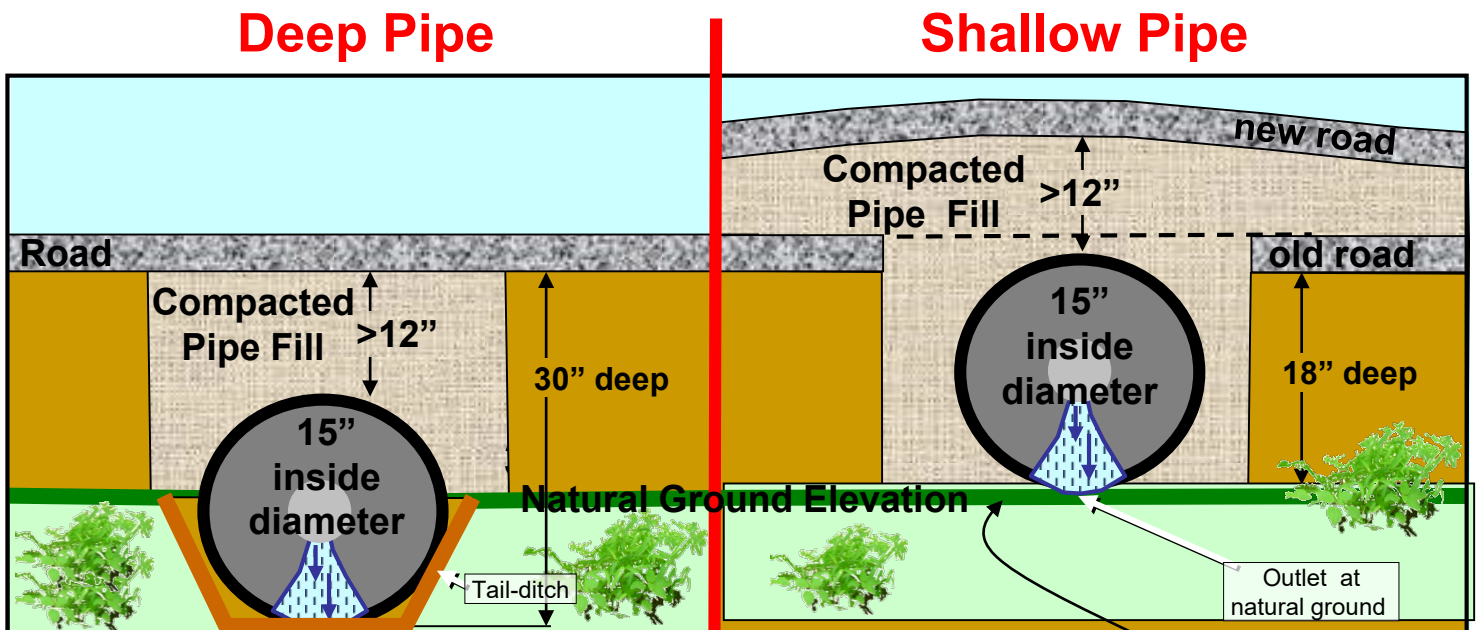

Looking at the crosspipe outlet, comparing deep and shallow pipe placements. Note the green "natural ground elevation" line. Traditional pipes dig down to obtain pipe cover. Shallow pipe placements are based off the natural ground elevation at the pipe outlet, and use fill to achieve pipe cover.

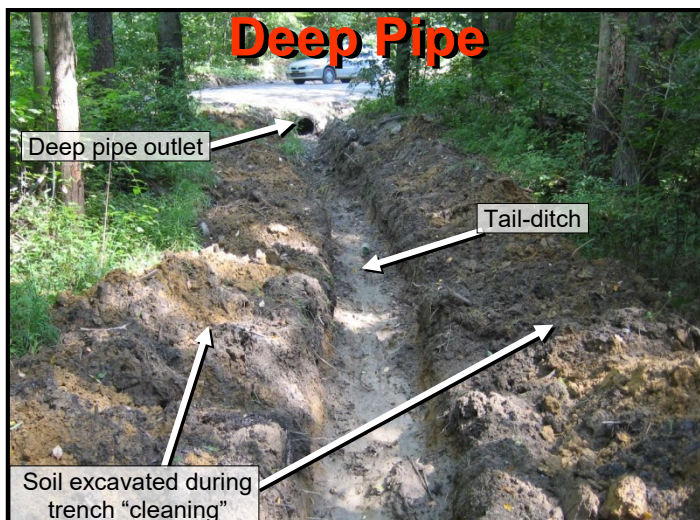



The crosspipe shown here is partially installed. Notice that the outlet of the pipe is at the elevation of the existing ground. No outlet trench or tail-ditch is required. At times, but not always, the top of the pipe may actually be ABOVE the existing road surface. The minimum of 12 inches of pipe cover will be obtained by importing material. When completed, the cover can create a grade break over the pipe.

If this pipe had been installed based off of the existing road surface elevation, the pipe would have been placed roughly 20 inches deeper into the road to achieve the necessary cover, resulting in a long and deep tail-ditch that would require on-going maintenance.

PROBLEMS ASSOCIATED WITH TRADITIONAL “DEEP PIPES”

When a pipe outlet is placed below the surface of the ground, it creates the need for continual maintenance of a “tail-ditch” to keep water flowing away from the road (illustrated in bottom left photo on page 1).

- Constant “cleaning” of tail-ditches costs money and generates large amounts of sediment.
- Unmaintained tail-ditches often clog, resulting in standing water at the outlet that can breed mosquitoes, saturate the road base, and lead to clogged pipes.
- Tail-ditches often carry drainage closer to streams and wetlands, making pollution more likely.

BENEFITS OF SHALLOW CROSSPIPES

- **Less Maintenance:** Having no tail-ditch to maintain will save time and money.
- **Less Problems:** Eliminating a tail-ditch reduces standing water to saturate road or breed mosquitoes.
- **Less Pollution:** Discharging drainage on natural ground gives maximum opportunity for infiltration.
- **Shallower inlet:** A shallow pipe often has less ditch and bank erosion at the pipe inlet.
- **Potential “grade break”:** The material imported to cover a *shallow crosspipe* can sometimes be used to create a grade break. These structures are designed to prevent water from flowing down the road by forcing it into road ditches. More info on grade breaks at www.dirtandgravelroads.org; resources: tech bulletins

INSTALLING A SHALLOW CROSSPIPE

1. **Determine proper outlet elevation:** Ideally, the bottom of the pipe outlet should rest on natural ground as pictured above.
2. **Dig pipe trench:** Pipe trench should be excavated based on outlet elevation. Ideally, pipe inlet should be placed in existing ditch line. Shoot for minimum ¼ inch per foot fall across trench (2%).
3. **Install pipe:** Separate bulletin about proper crosspipe installation available at: www.dirtandgravelroads.org; resources: tech bulletins.
4. **Cover pipe:** Shallow pipe installations typically require 30 to 60 tons of fill to obtain necessary pipe cover. Proper compaction is critical to avoid settling and pipe strain. Pipes should be covered with a minimum of 12 inches of compacted material (not including surface aggregate) before allowing traffic on the road. The fill should be tapered into the existing road elevation on either side of the pipe. The amount of fill needed and length of fill taper will depend on site conditions such as road slope and pipe depth. Transitions should be sufficiently long to accommodate expected traffic. In some cases, a grade break can be created with fill that forces water off the road and into the ditches and pipe.
5. Take care to maintain pipe cover during future grading cycles.

“Crosspipe elevation should be determined by the elevation of the existing ground at the pipe outlet, not of the elevation of the road surface”



This shallow pipe is being covered with fill. Here the fill will be approximately 18 inches above the existing road at the pipe, and taper for 50+ feet in both directions.

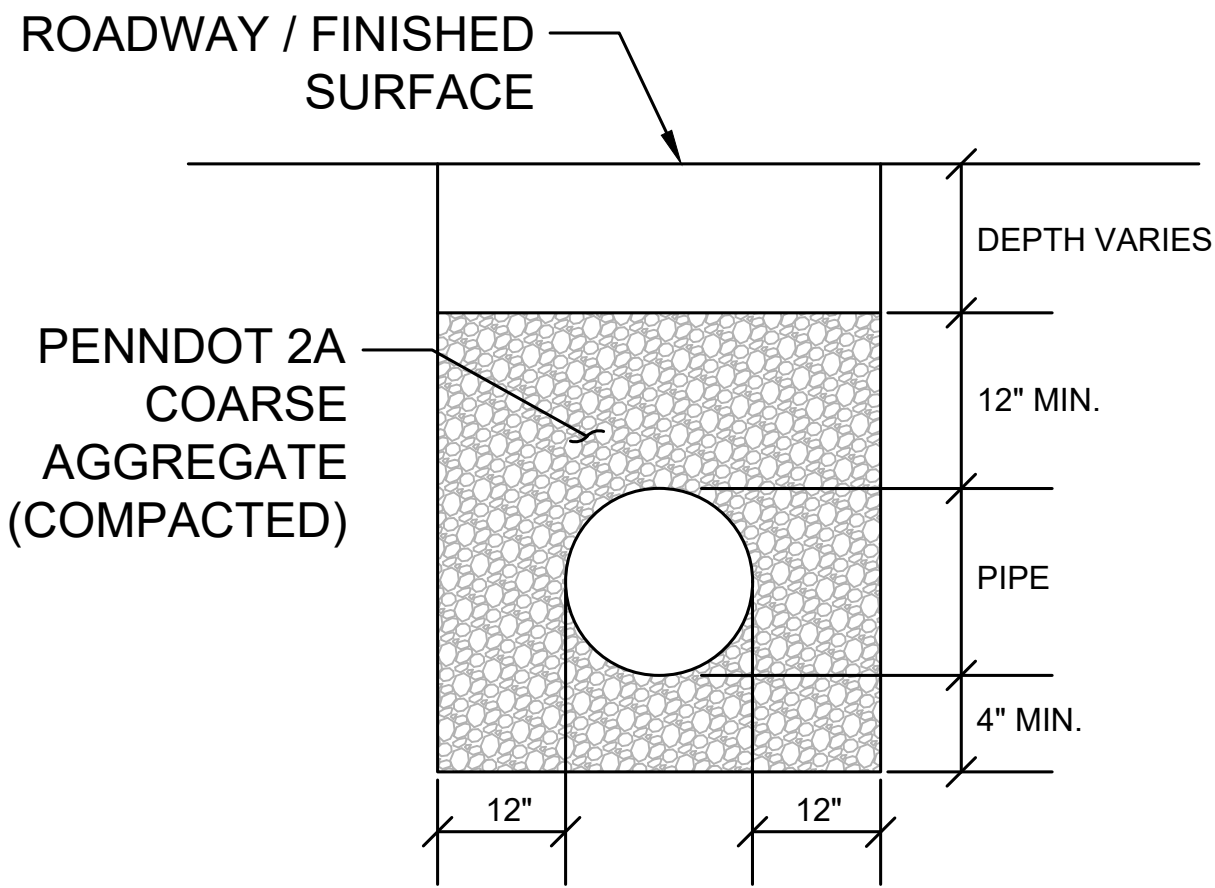

PIPE BEDDING DETAIL

NOT TO SCALE

Technical Bulletin

Stacked Stone Headwalls



PennState

1/2019



Headwall or Endwall– An integrated wall located at either end of drainage pipe or a stream crossing structure. A wall built at a pipe inlet is a **headwall**. A wall built at a pipe outlet is an **endwall**.



Stable headwall with bankwall



Stable stacked stone endwall

PURPOSE – Headwalls and Endwalls protect vulnerable pipe ends and support the road edge. In addition, these walls also serve to direct flow, to reduce erosion, and to visually identify pipes along the road. When properly constructed, a headwall can improve pipe efficiency and an endwall can stabilize a steep road bank.

BENEFITS – Properly installed headwalls and endwalls provide multiple maintenance and environmental benefits which are explained in the Center’s separate “Headwalls and Endwalls” technical bulletin. This bulletin focuses on the construction of these walls with the most common building material, natural stone.

WHERE TO USE

- Use with all road drainage pipes, including crosspipes, through-pipes, bank pipes and driveway pipes.
- Use with all stream crossing structures, including pipes, box culverts, and bridges.

CONSIDERATIONS

- Headwalls and Endwalls are an integral part of drainage pipes and road stream crossings.
- Natural stone headwalls and endwalls often combine both cost effectiveness and durability.
- The strength of a rock wall comes from the weight and friction of the interwoven stacked stones.
- The stability of a stacked wall results from tightly fitting stones, staggered joints, proper canter, and the use of sufficient “tie-ins” to compacted soil (multiple deadman anchors).

Typical Requirements for headwalls and Endwalls constructed of stone

Materials: Any size and shape stone can be used. However, construction will be easier with rocks of a uniform thickness, flat on at least two sides, that can be handled by one person. Where native stone is unavailable in or near the road corridor, headwalls and endwalls can be constructed using purchased landscape stone or retaining wall blocks. Whether your stones are rectangular or irregularly shaped, the key to a durable dry-laid stone wall is to interlock the stones and to tie the stones to the soil behind the wall. Attention to detail during construction separates a good wall from a poor wall. Many of the stone walls constructed by the Civilian Conservation Corps (CCC) in the 1930s are still functioning today.

Equipment: Gloves, a shovel, a hand tamper and an eye for detail are all that is needed. A pick or a prybar are handy to have. A sledgehammer may help to adjust embedded stones. However, a backhoe and a skilled operator can save time and labor when large rocks are available. Don’t forget your safety equipment.

Stone Headwall Construction

1. If necessary, excavate around the pipe end to make room for the wall. Walls typically extend 2-3 times the diameter of the pipe on each side of the pipe. The base of the wall should be level with, or lower than, the bottom of the pipe inlet.
2. Use rocks with flat sides in the face of the wall. Use the largest available stones for the base course and slightly smaller stones in consecutive courses. Take care to stagger the joints and slightly cant the wall toward the road in each successive course. Periodically install a longer stone into the wall face with the long axis perpendicular to the face of the wall. Compact this “deadman” stone into the wall backfill.
3. Backfill and compact behind the wall in layers as it is built. Use material that is damp enough for compaction and free of large roots and clumps of organic material.
4. Build the wall to the top of the pipe. Place a large capstone over the top of the pipe to bridge the two halves of the wall together and protect the pipe. If a large stone is unavailable, continue to build the wall to attain a stable span of smaller stone over the pipe, alternating the joints in the rock.

Important Considerations

- Be aware that the size and shape of headwalls will vary based on pipe size, road and pipe alignment, stream or ditch alignment, and approach velocities.
- On roads with linear grade, construct headwalls to “plug” the inboard ditch and to turn flow into the pipe.
- Integrate a bankwall into the headwall design where unstable slopes exist at the pipe inlet.
- Be sure that the wall backfill is sufficiently compacted behind the wall and around the “deadman” anchors.
- Headwalls can be reinforced by placing fabric between successive layers of rock, and tying the fabric into the backfill, creating a geosynthetic “deadman.” This technique may be especially useful when working with rounded stone or landscape block.
- Consider identifying pipe ends with a reflective post or similar marker.

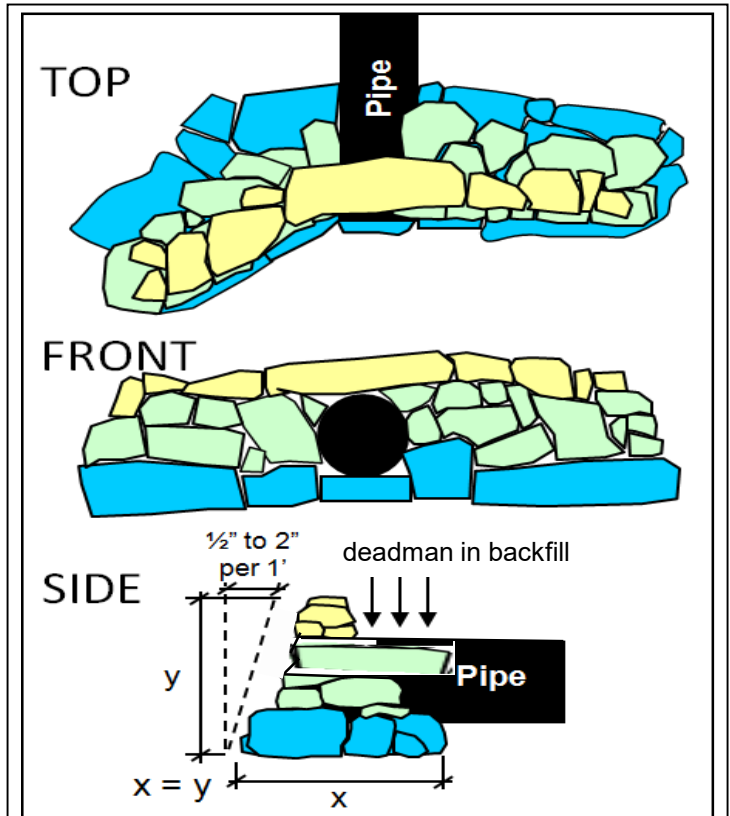

Plan views of a stone headwall. Note that the base width should be equal to the height, the face should be sloped or canted back, seams should be overlapped like bricks, and “deadman” anchors should be mixed throughout.



A properly constructed natural stone headwall can last for decades.

Technical Bulletin

French Mattress

FRENCH MATTRESS – A structure under a road consisting of clean coarse rock wrapped in geotextile through which water can freely pass. French Mattresses are used in saturated soils, such as in wetlands, to support the roadbed while allowing unrestricted water movement.

CRITERIA FOR FRENCH MATTRESS USE

- Areas where roadside springs and low gradient road ditches result in road base saturation.
- Areas where springs under the road saturate the road base or come to the surface in the road.
- Areas where the road lays over soils with a high water table, such as wetlands and creek bottoms.

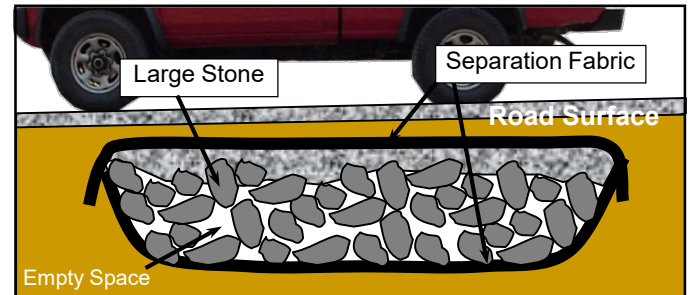

Side view schematic of a French Mattress.

BENEFITS OF FRENCH MATTRESSES

- Stabilizes the road base in areas where the road is weakened by water saturation.
- Allows for the free movement of water through road base (can be bi-directional).
- Maintains dispersed flows and prevents gully erosion associated with concentrated outlets.
- Can be used in wetland situations where a traditional pipe may lower the wetland water level.
- Requires little or no maintenance and has a long service life.
- Unlike pipes, a French Mattresses effectively reduces damming by beavers.
- Maintains floodplain connectivity through the roadway.
- Effectively insulates the road surface from water under the road, keeping the travel-way high and dry.

IMPORTANT MATTRESS CONSIDERATIONS

- Mattresses are not suitable replacements for road drainage pipes, or anywhere concentrated overland flow carries sediment. These flows will clog the mattress over time and are to be handled by drainage pipes..
- Mattress size is flexible. In the examples below the smaller mattress allows roadside springs to bleed through the road base while maintaining road stability. The larger mattress creates a stable foundation for the road through an area of soft wet soils.
- A French Mattress should be covered by a minimum of 12" of compacted fill material.
- In most situations the mattress should be level end to end (with the road alignment).
- A French Mattress should provide unrestricted flow through the road. In wetland situations, the side slope may be flat or minimal. In sloped areas a 1- to 2-percent fall from inlet to outlet will aid drainage.
- The mattress must be free draining at the outlet to avoid ponding water beneath the road.



The small mattress shown during construction was installed to drain a group of small hillside seeps that saturated the roadway. The larger mattress is being constructed to create a free draining and stable road base in a low land stream bottom.

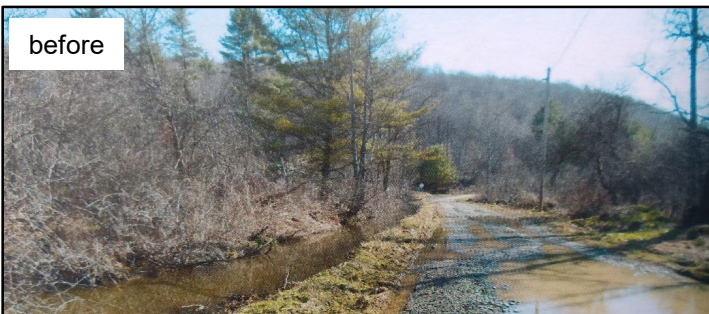

CONSTRUCTION SEQUENCE

The mattress shown on the left traverses a wide wetland. The numbers refer to picture sequence.

1. Excavate the mattress to desired depth and slope, allowing for min 12 inches of compacted cover over the mattress. Place geotextile fabric in the trench. Allow enough fabric on the ends to overlap the top piece of geotextile in the finished mattress.
2. Place porous AASHTO 1 stone on top of the fabric and spread into a uniform bed of the desired depth.
3. Place a piece of fabric ovetop of the installed stone. Be sure to overlap all fabric joints by at least 12 inches. Leave the stone exposed along the road edges.
4. Shape and compact fill ovetop of the finished mattress. Establish the desired road surface shape in the fill. Place enough fill to ensure a minimum of 12" of compacted cover once the fill and surface aggregate are installed.

MATERIALS REQUIRED FOR A FRENCH MATTRESS

- **Geotextile fabric** (Class 1 Non-woven). Separation fabric around the mattress allows water to pass through while blocking fine silt and clay, which would eventually clog the structure.
- **Clean stone**. It is important to use clean stone. Clean stone is relatively uniform in size with no fine material. Typically 3- to 4-inch-diameter stone is used. Smaller stone should be avoided, as it requires lateral confinement to stabilize. Additionally, larger stone will increase the bridging potential and the flow capacity of the mattress.

EQUIPMENT REQUIRED FOR A FRENCH MATTRESS

- **Excavator/backhoe**: Needed for excavation; helps to spread stone after dumping.
 - **Trucks**: Needed to import clean stone and haul away excavated material.
 - **Hand Tools**: Rakes and shovels to move and level stone.
 - **Grader***: To establish uniform depth and shape of fill.
 - **Compaction***: A vibratory roller is needed to compact fill.
- * *Alternative equipment can be used on smaller mattresses*

Reminder: A French Mattress should not be used to handle storm drainage. The sediment load carried in storm flows will eventually clog the mattress.

In the example above a French Mattress is used to convey wetland flows while providing a stable road base.

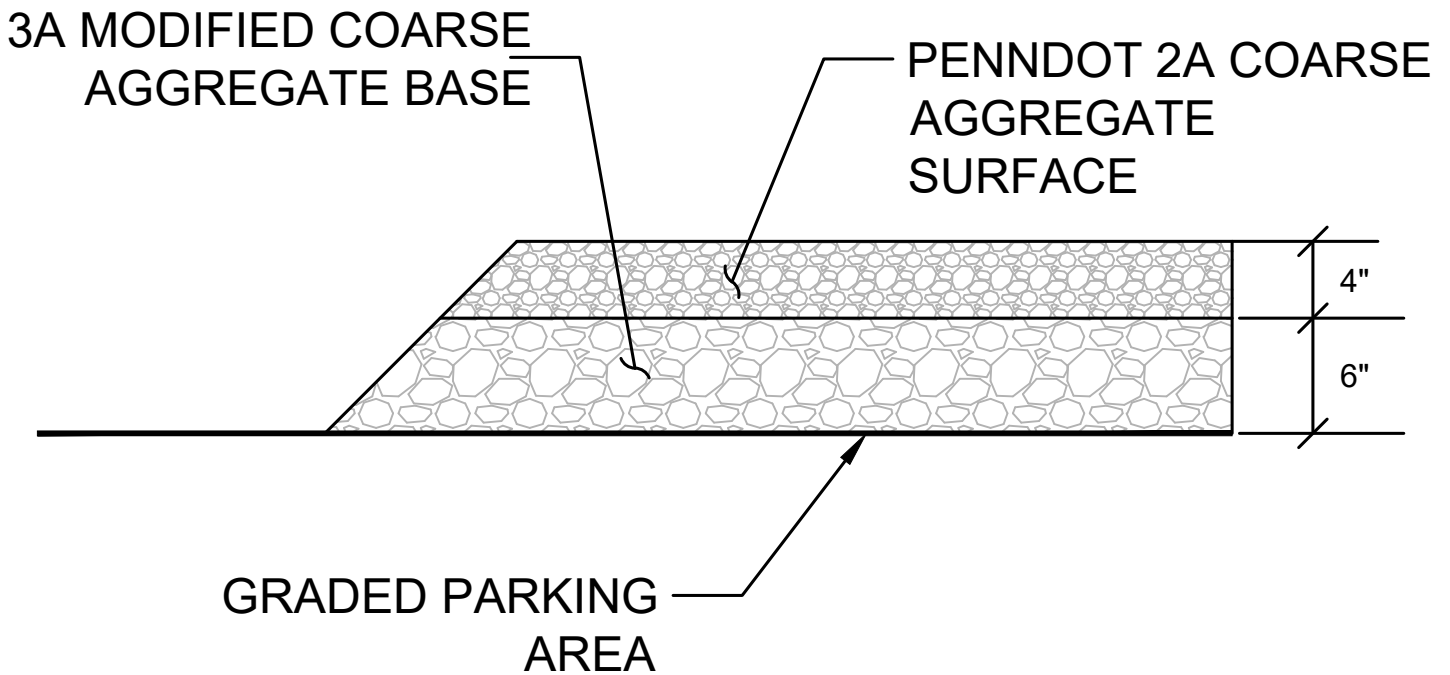

NOTES:

1. PROVIDE PARKING AREA AT LOCATION(S) IDENTIFIED BY PGC STAFF.
2. EXCAVATE AND GRADE AREA TO CONFORM TO AND BLEND WITH EXISTING GROUND CONTOURS AND ALLOW RUNOFF TO SHEET FLOW ACROSS SITE.

PARKING AREA DETAIL

NOT TO SCALE